



GB

# Installation,- Operating and Maintenance Instructions

## HADEF Wall-mounted Jib Crane

Type 320H      with Spur Gear Hoist Type 24/98H  
Type 320E      with Electric Chain Hoist Type 66/04AK  
Type 650        with Electric Chain Hoist Type 62/05



**HADEF**

 **NOTICE!**

The installation or mounting instructions for incomplete machines you'll find in chapter "Installation"

© by Heinrich de Fries GmbH

Heinrich de Fries GmbH, Gauss Str. 20, D-40235 Düsseldorf

Heinrich De Fries GmbH will be named HADEF in the following text.

Original operating- and maintenance instructions in German language.

Translation in other languages is made of the German original.

A copy may be requested in writing or is available for download on [www.hadef.com](http://www.hadef.com)

Subject to changes.

**Table of Contents**

|           |  |           |
|-----------|--|-----------|
| <b>1</b>  | <b>Information.....</b>                        | <b>4</b>  |
| <b>2</b>  | <b>Safety .....</b>                            | <b>5</b>  |
| 2.1       | Warning notice and symbols .....               | 5         |
| 2.2       | Duty of care of the owner.....                 | 5         |
| 2.3       | Requirements for the operating personnel ..... | 6         |
| 2.4       | Appropriate use .....                          | 6         |
| 2.5       | Basic safety measures .....                    | 7         |
| <b>3</b>  | <b>Transport and Storage .....</b>             | <b>8</b>  |
| 3.1       | Transport.....                                 | 8         |
| 3.2       | Safety device for transport.....               | 8         |
| 3.3       | Storage .....                                  | 8         |
| <b>4</b>  | <b>Description.....</b>                        | <b>9</b>  |
| 4.1       | Areas of application.....                      | 9         |
| 4.2       | Design .....                                   | 9         |
| 4.3       | Function description .....                     | 10        |
| 4.4       | Important components .....                     | 10        |
| <b>5</b>  | <b>Technical data .....</b>                    | <b>11</b> |
| <b>6</b>  | <b>Installation .....</b>                      | <b>12</b> |
| 6.1       | Wall fastening .....                           | 12        |
| 6.2       | Table of screws.....                           | 13        |
| 6.1       | Tools.....                                     | 13        |
| <b>7</b>  | <b>Operation .....</b>                         | <b>14</b> |
| <b>8</b>  | <b>Commissioning .....</b>                     | <b>15</b> |
| 8.1       | General .....                                  | 15        |
| <b>9</b>  | <b>Safety check .....</b>                      | <b>16</b> |
| <b>10</b> | <b>Functional test.....</b>                    | <b>17</b> |
| 10.1      | Checks before initial start-up.....            | 17        |
| 10.2      | Functional test .....                          | 17        |
| <b>11</b> | <b>Maintenance.....</b>                        | <b>18</b> |
| 11.1      | General .....                                  | 18        |
| 11.2      | Monitoring .....                               | 18        |

- 12 Inspection ..... 19**
- 12.1 Periodic checks ..... 19
- 12.2 Inspection intervals ..... 19
  
- 13 Service ..... 20**
- 13.1 Slewing bracket ..... 20
- 13.2 Lubricant - Selection ..... 20
- 13.3 Lubricant for food industry – Selection (as option\*) ..... 20
  
- 14 Trouble ..... 21**
- 15 Remedy ..... 22**
- 16 Decommissioning ..... 23**
- 16.1 Temporary decommissioning ..... 23
- 16.2 Final decommissioning/disposal ..... 23
  
- 17 Additional documents ..... 24**
- 17.1 Operating instructions for cranes ..... 24

## **1 Information**

HADEF products meet European Union requirements, in particular the EU Machine Directive (2006/42/EG).

The entire company works acc. to a certified quality assurance system as per ISO 9001.

The production of components at HADEF is subject to strict, intermediate checks.

After assembly, each HADEF product is subject to a final test with overload.

For the operation of hoists, the accident prevention regulations BGV D8, BGV D6 and BGR 500 apply in Germany, amongst others.

The stated performance of the devices and meeting any warranty claims require adherence to all instructions in this manual.

Before delivery, all HADEF products are packed properly. Check the goods after receipt for any damage caused during transport. Report any damage immediately to the forwarding agent.

This manual allows a safe and efficiently use of equipment. Images of this manual are for a principle understanding and can be different from the real design.

### **NOTICE!**

We refer to the prescribed equipment tests before initial start-up, before putting back into operation and the regular periodic inspections.

In other countries any additional national regulations must be observed.

## 2 Safety

### 2.1 Warning notice and symbols

Warnings and notice are shown as follows in these instructions:

|  |   |
|--|---|
|  <b>DANGER!</b> | This means that there is a high risk that leads, if it is not avoided, to death or severe injury. |
|--|---|

|   |   |
|---|---|
|  <b>WARNING!</b> | This means that there is a risk that could lead, if it is not avoided, to death or severe injury. |
|---|---|

|   |  |
|---|--|
|  <b>CAUTION!</b> | This means that there is little risk that could lead, if it is not avoided, to slight injury or damage to the device or its surrounding. |
|---|--|



### **NOTICE!**

Gives advice for use and other useful information.



Danger from electricity.



Danger from explosive area.

### 2.2 Duty of care of the owner

The unit was designed and built following a risk analysis and careful selection of the harmonized standards that are to be complied with, as well as other technical specifications. It therefore represents state-of-the-art technology and provides the highest degree of safety.

Our delivery includes the hoist supplied beginning at its suspension and ending at the load hook and if supplied with control, the control line/hose that leads to the hoist. Further operating material, tools, load attaching devices as well as main energy supply lines must be assembled according to the valid rules and regulations. For explosion-proof equipment, all these parts must be approved for use in area prone to explosion, or they must be suitable for use in area prone to explosion. The owner is responsible for this.

However, in everyday operation this degree of safety can only be achieved if all measures required are taken. It falls within the duty of care of the owner/user of the devices to plan these measures and to check that they are being complied with.

Complete the operating and installation instructions by any instructions (regarding supervision or notifications) that are important for the special kind of use of the equipment, i.e. regarding organization of work, work flow and human resources.

In particular, the owner/user must ensure that:

- The unit is only used appropriately.
- The device is only operated in a fault-free, fully functional condition, and the safety components, in particular, are checked regularly to ensure that it is functioning properly.
- The required personal protective equipment for the operators, service and repair personnel is available and is used.
- The operating instructions are always available at the location where the equipment is used and that they are legible and complete.
- The unit is only operated, serviced and repaired by qualified and authorized personnel.
- This personnel is regularly trained in all applicable matters regarding safety at work and environmental protection, and that they are familiar with the operating manual and, in particular, the safety instructions it contains.
- Any safety and warning signs on the devices are not removed and remain legible.
- Devices for use in area prone to explosion must (from customer's side) be earthed with a shunting resistor of  $< 10^6 \Omega$  against earth.

|   |  |
|---|--|
|  <b>WARNING!</b> | It is not allowed to make constructive changes of the equipment! |
|---|--|

### 2.3 Requirements for the operating personnel

The units may only be operated by qualified persons that are appropriately trained and that are familiar with it. They must have their employer's authorisation for operation of the units.

Before starting work, the operating personnel must have read the operating and installation instructions, especially the chapter "Safety Instructions".

This is especially important for operating personnel that rarely uses the equipment, i.e. for installation or maintenance work.

 **DANGER!**

In order to avoid severe injury, please pay attention to the following when using the equipment:

- Use protective clothes/equipment.
- Do not wear long hair hanging down open.
- Do not wear rings or other jewellery.
- Do not wear cloths that are too big/wide.

### 2.4 Appropriate use

The permitted safe working load of the devices must not be exceeded! An exception can be made during the load test, carried out by a licensed qualified person in accordance with the accident prevention regulations UVV BGV D6 before initial operation.

- The permitted environmental temperature during equipment operation is  $-20^{\circ}\text{C}$  up to  $+40^{\circ}\text{C}$ !
- Defective devices and load suspension devices must not be used until they have been repaired! Only original HADEF spare parts must be used. Non-compliance will result in any warranty claims on HADEF becoming void.
- Liability and warranty will become void if unauthorized modifications of the units are made by the user!

A manually slewing of jib.

Jib range of wall mounted cranes  $180^{\circ}$  when mounted at the wall.

Jib range of jib cranes  $270^{\circ}$ .

The cranes are adequate for using with manually and electrical hoisting units.

#### **NOTICE!**

If the units are not used appropriately, it is not possible to ensure safe operation.

The owner and operator have sole liability for all personal injury and damage to property arising from inappropriate use.

 **DANGER!**

It is not allowed:

- pulling loose of stuck loads, dragging of loads and inclined pulling is not allowed.
- in explosive atmosphere, except the unit is especially modified for it and marked by an indication label
- to transport people
- persons must not stand under a suspended load

## 2.5 Basic safety measures

- Observe installation-, operation and maintenance instruction.
- Take notice of caution notes at units and in the manual
- Observe safety distances.
- Take care for a free view on the load.
- Only use the hoists appropriately.
- The equipment is to be used exclusively for movement of goods. Under no circumstances my persons be moved.
- Never load the devices beyond their working load limit.
- Pay attention to the accident prevention regulations (UVV).
- Should the hoist be used outside of Germany, please pay attention to the national regulations that apply.
- Supporting structures and load-attached devices used in conjunction with this equipment must provide an adequate safety factor to handle the rated load plus the weight of the equipment. In case of doubt, consult a structural engineer.
- If the equipment has not been used for a period of time, carry out visual checks of all main components such as chains, load hooks etc. and replace any damaged parts with new, original spare parts before putting the equipment back into operation!
- Do not use a hoist that is defective, pay attention to any abnormal noise it makes during operation.
- Stop working immediately in case of disturbances and remedy failures.
- Any damage and faults must be reported to a responsible supervisor immediately.
- If the unit is put into motion, any persons in the immediate vicinity must be informed by calling to them!
- Please pay attention to the regulations for load carrying devices UVV BGR500 for both positive and non-positive methods of attaching loads.
- The lifting tackle or the load must be securely attached to the hook and be seated at the bottom of the hook.
- The safety catch of hooks must be closed.
- When charged, the housing may not be in contact somewhere.
- Observe separate installation-, operation and maintenance instruction of hoists.
- Please consider oscillation of the load and stopping distance.
- Make sure that the device stands stable.

### 3 Transport and Storage



#### **CAUTION!**

Transport may only be done by qualified personnel. No liability for any damage resulting from improper transport or improper storage.

#### 3.1 Transport

HADEF devices are checked and if so adequately packed before delivery.

- Do not throw or drop the equipment.
- Use adequate means of transport.

Transport and means of transport must be suitable for the local conditions.

#### 3.2 Safety device for transport



#### **NOTICE!**

Should a safety device for transport exist, please remove it before commissioning.

#### 3.3 Storage

- Store the equipment at a clean and dry place.
- Protect the equipment against dirt, humidity and damage by an appropriate cover.
- Protect hooks, wire ropes, chains and brakes against corrosion.





## 4 Description

### 4.1 Areas of application

The devices must be as far as possible installed in a covered room.

If they are used in the open, protect the units against the effects of weather such as rain, hail, snow, direct sunshine, dust, etc. - we recommend to use a cover in parking position. If the device is set up in a continuously humid environment with strong temperature fluctuations, the correct functionings are endangered by the forming of condensation.

Ambient temperature: - 20°C up to + 40°C. Humidity: 100 % or less but not under water

|   |  |
|---|--|
|  |  <b>DANGER!</b> |
| It is not permitted to use the unit in an area at risk from explosion!            |  |

### 4.2 Design

HADEF Wall-mounted jib cranes are designed to DIN 15018 H2/B2 for following different versions:

#### Type 320H

with spur gear hoist type 24/98HR  
with monorail push travel trolley



Illustration 1

#### Type 320E

with electric chain hoist type 66/04AKR  
with monorail push travel trolley  
power supply included



Illustration 2

#### Type 650

with electric chain hoist type 62/05  
with monorail push travel trolley  
power supply included



Illustration 3

Delivery with electric chain hoist:

Standard design: 3-phase current 400V/50Hz – 16A, electrical connection of lifting unit by plug connection. Protection class IP55, usable for in- and outdoor.

**4.3 Function description**

**Direction of movement Type 320H**

- 1 manually trolley driving
- 2 manually slewing
- 3 manually lifting and lowering

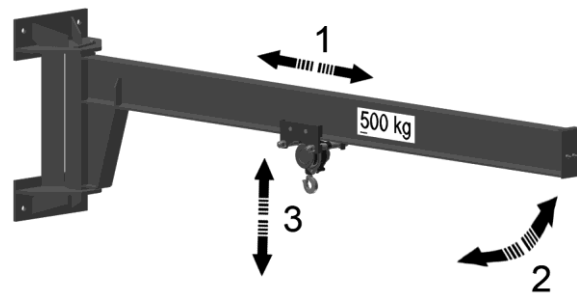

Illustration 4

**Direction of movement Type 320E und Type 650**

- 1 manually trolley driving
- 2 manually slewing
- 3 electrically lifting and lowering

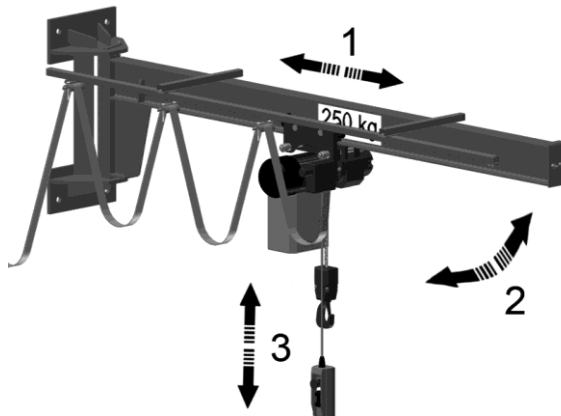

Illustration 5

**4.4 Important components**

**4.4.1 Jib**

Profile steel beam, with ball bearings

**4.4.2 Bracket**

Profile steel

**4.4.3 Embracing bracket – as option**

For installation on to columns and beams

**4.4.4 Fixing device – as option**

For locking the jib

**4.4.5 Slewing end stops – as option**

Adjustable slewing end stops

**5 Technical data**

| Capacity | Radius of jib | Span | Low headroom dim. | Low headroom dim. | Low headroom dim. |     |     |       |       | Weight* |
|----------|---------------|------|-------------------|-------------------|-------------------|-----|-----|-------|-------|---------|
|          | C             | A    | H                 | H                 | H                 | H1  | k   | FH    | FV    |         |
|          | mm            | mm   | mm                | mm                | mm                | mm  | mm  | N     | N     | kg      |
| 125      | 2000          | 1756 | 244               | 393               | 411               | 200 | 160 | 7490  | 3320  | 80      |
|          | 3000          | 2756 |                   |                   |                   | 200 | 160 | 12520 | 3700  | 110     |
|          | 4000          | 3756 |                   |                   |                   | 240 | 190 | 16730 | 4490  | 183     |
|          | 5000          | 4756 |                   |                   |                   | 240 | 190 | 22070 | 4780  | 207     |
|          | 6000          | 5756 |                   |                   |                   | 284 | 230 | 25160 | 6110  | 338     |
| 250      | 2000          | 1756 | 244               | 393               | 411               | 200 | 160 | 11390 | 4850  | 80      |
|          | 3000          | 2756 |                   |                   |                   | 240 | 190 | 16870 | 5610  | 155     |
|          | 4000          | 3756 |                   |                   |                   | 240 | 190 | 23710 | 5910  | 183     |
|          | 5000          | 4756 |                   |                   |                   | 284 | 230 | 26830 | 7120  | 295     |
|          | 6000          | 5756 |                   |                   |                   | 284 | 230 | 33520 | 7480  | 328     |
| 500      | 2000          | 1756 | 244               | 393               | 444               | 240 | 190 | 17150 | 8340  | 134     |
|          | 3000          | 2756 |                   |                   |                   | 240 | 190 | 27370 | 8590  | 158     |
|          | 4000          | 3756 |                   |                   |                   | 284 | 230 | 31850 | 9730  | 263     |
|          | 5000          | 4756 |                   |                   |                   | 353 | 230 | 36040 | 10990 | 380     |
|          | 6000          | 5756 |                   |                   |                   | 353 | 230 | 44800 | 11480 | 425     |
| 1000     | 2000          | 1729 | 289               | 453               | 507               | 284 | 230 | 24640 | 15030 | 197     |
|          | 3000          | 2729 |                   |                   |                   | 253 | 230 | 33480 | 16050 | 291     |
|          | 4000          | 3729 |                   |                   |                   | 353 | 230 | 46510 | 16530 | 336     |
|          | 5000          | 4729 |                   |                   |                   | 353 | 230 | 59940 | 17010 | 380     |
|          | 2000          | 1698 |                   |                   |                   | 359 | 610 | 620   | 353   | 230     |
| 3000     | 2698          | 353  | 230               | 48580             | 22820             |     |     |       | 291   |         |
| 4000     | 3698          | 353  | 230               | 67380             | 23320             |     |     |       | 338   |         |
| 2000     | 2000          | 1698 | 446               | 610               | 620               | 353 | 230 | 38580 | 28140 | 247     |
|          | 3000          | 2698 |                   |                   |                   | 353 | 230 | 61840 | 28620 | 291     |

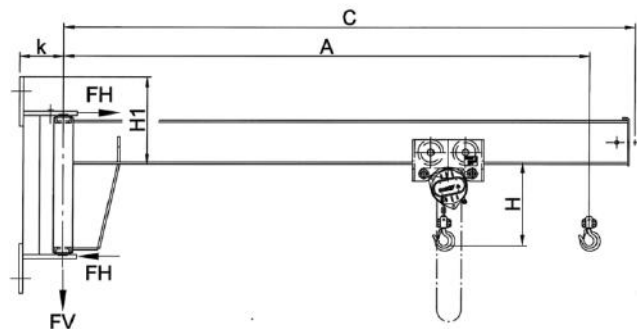

**Illustration 6**

\*Weight without lifting unit and standard profile  
 Listed data are standards. Intermediate sizes possible.  
 Find order-related data on type plates of crane and lifting unit.

## 6 Installation

Assembly depends on the local environment. The crane must be assembled stress-free. The runway must be perfect.

Operating regulations for cranes in accordance with §§ 29-43 of the accident prevention regulations "cranes" BGV D6.

An end stop is provided at the end of jib.

Generally, additional lifting gear (e.g. fork lift, lifting platforms) will be required for the assembly. These must take the weight of the devices safely.

### 6.1 Wall fastening

- prepare fixing holes in the wall
- put the wall bracket (1) onto the wall
- Fix it with screws, discs and nuts (2) (on site)
- Put through axle (4)
- Adjust with water-level
- Tighten screws (2)
- Remove axle (4) again
- Push the jib with ball bearings (3) into the wall bracket
- Put through the axle (4) from the bottom or from the top again.
- Protect with pin lock (5) and screw (6)
- Check eventually existing end stops.

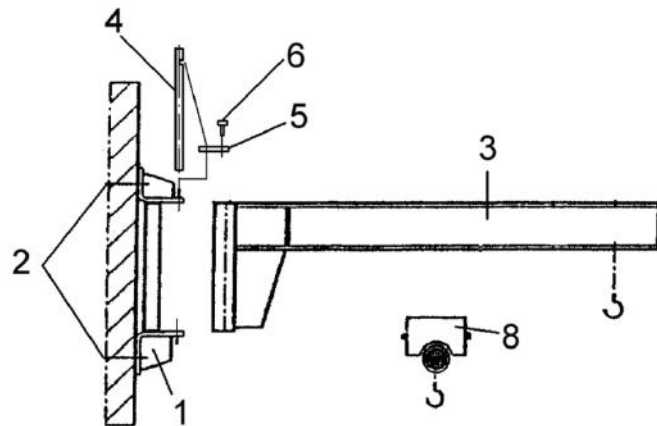

Illustration 7

For mounting of hoist unit (8) and power supply (7) see separate instruction.

Distance of fixing holes

| Capacity<br>kg | Radius of jib<br>mm | Bracket<br>Type | A<br>mm | B<br>mm | C<br>mm | D<br>mm | E<br>mm | Hole Ø<br>mm |
|----------------|---------------------|-----------------|---------|---------|---------|---------|---------|--------------|
| 125            | 2000                | I               | 784     | 370     | 678     | 270     | 424     | 27           |
|                | 3000                | I               | 784     | 370     | 678     | 270     | 424     | 27           |
|                | 4000                | II              | 886     | 440     | 780     | 340     | 526     | 27           |
|                | 5000                | II              | 886     | 440     | 780     | 340     | 526     | 27           |
|                | 6000                | III             | 1086    | 440     | 980     | 340     | 726     | 30           |
| 250            | 2000                | I               | 784     | 370     | 678     | 270     | 424     | 27           |
|                | 3000                | II              | 886     | 440     | 780     | 340     | 526     | 27           |
|                | 4000                | II              | 886     | 440     | 780     | 340     | 526     | 27           |
|                | 5000                | III             | 1086    | 440     | 980     | 340     | 726     | 30           |
|                | 6000                | III             | 1086    | 440     | 980     | 340     | 726     | 30           |
| 500            | 2000                | II              | 886     | 440     | 780     | 340     | 526     | 27           |
|                | 3000                | II              | 886     | 440     | 780     | 340     | 526     | 27           |
|                | 4000                | III             | 1086    | 440     | 980     | 340     | 726     | 30           |
|                | 5000                | IV              | 1286    | 440     | 1180    | 340     | 926     | 30           |
|                | 6000                | IV              | 1286    | 440     | 1180    | 340     | 926     | 30           |
| 1000           | 2000                | III             | 1086    | 440     | 980     | 340     | 726     | 30           |
|                | 3000                | IV              | 1286    | 440     | 1180    | 340     | 926     | 30           |
|                | 4000                | IV              | 1286    | 440     | 1180    | 340     | 926     | 30           |
|                | 5000                | IV              | 1286    | 440     | 1180    | 340     | 926     | 30           |
| 1500           | 2000                | IV              | 1286    | 440     | 1180    | 340     | 926     | 30           |
|                | 3000                | IV              | 1286    | 440     | 1180    | 340     | 926     | 30           |
|                | 4000                | IV              | 1286    | 440     | 1180    | 340     | 926     | 30           |
| 2000           | 2000                | IV              | 1286    | 440     | 1180    | 340     | 926     | 30           |
|                | 3000                | IV              | 1286    | 440     | 1180    | 340     | 926     | 30           |

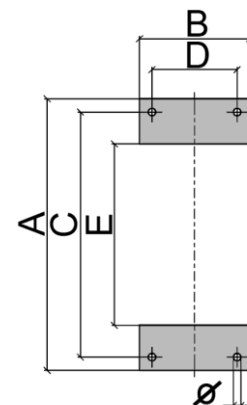

Illustration 8

## 6.2 Table of screws





Tighten the screws with tightening moment mentioned in the table

| Thread | Tightening moment (Nm) in property class |      |
|--------|--|------|
|        | 8.8                                      | 10.9 |
| M 6    | 10,4                                     | 15,3 |
| M 8    | 25,3                                     | 37,2 |
| M 10   | 51                                       | 75   |
| M 12   | 87                                       | 128  |
| M 14   | 139                                      | 205  |
| M 16   | 214                                      | 314  |
| M 18   | 280                                      | 390  |
| M 20   | 431                                      | 615  |
| M 22   | 530                                      | 750  |
| M 24   | 742                                      | 1159 |
| M 27   | 1000                                     | 1400 |
| M 30   | 1350                                     | 1900 |
| M 33   | 2000                                     | 2800 |

coefficient of friction 0,12 - 0,14  $\mu$ ges

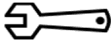
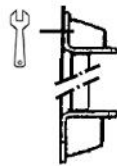
## 6.1 Tools

No special tools necessary.

| Size         | Tool  | Use  |   |
|--------------|---|--|---|
| SW41<br>SW46 |  | Wall bracket I – II<br>Wall bracket III - IV |  |
| diff.        |  | diff.  |   |
|              |  |  |   |
|              |  |  |   |

## 7 Operation

Only people that are familiar with the operation of the lifting devices and cranes may be entrusted with their operation. They must be authorized by the employer for the operation of the equipment. The employer must ensure that the operating instructions are available near the equipment and that they are accessible for the operating personnel.

slewing by hand  
depended of mounting heigth, at load or jib

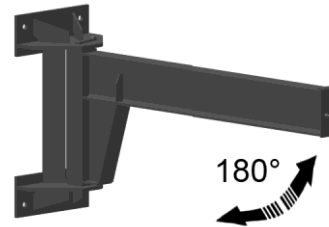

Illustration9

## 8 Commissioning

### 8.1 General

Should the unit be used in Germany, please observe the accident prevention regulations, in particular BGV D8, BGV D 6 and BGR 500 (VBG 9a).

For other countries: Inspections as above. Please observe the national rules and regulations and the instructions in this manual!

#### **NOTICE!**

Hoists up to 1000 kg capacity and without motor-driven trolleys of hoisting unit must be tested by a “qualified person” before putting into operation for the first time.

Hoists of 1000 kg capacity and up or with more than one motor-driven hoist movement; i.e. lifting and trolley movement, must be tested by a “licensed qualified person” before putting in operation.

An exception is “hoists ready for operation” acc. To BGV D6 II§25(4) with EU-declaration of conformity.

#### **Definition “qualified person” (former expert)**

A “qualified person” has learned, due to occupational training and experience and the job that the person has done, the skills needed to tests the material for one’s work.

#### **Definition “licensed qualified person” (former approved expert)**

A “licensed qualified person” has, due through special occupational training, knowledge about testing of the material for one’s work and knows the national accident prevention regulations and other prescriptions and technical regulations. This person must test the material for one’s work regularly with regard to design and kind of use. The license will be given to qualified person be the approved supervision authorities (ZÜS).

## **9 Safety check**

Before putting into service initially or when putting back into service, it must be checked whether:

- All fastening screws (if existent), socket pins, flap socket and safety devices are tightened and secured.



### **10 Functional test**

#### **10.1 Checks before initial start-up**

##### **Design**

- Check all screws and safety connections.

#### **10.2 Functional test**

##### **Function – crane slewing unit**

- Correct slewing of crane jib
- Correct position of end stops

## **11 Maintenance**

### **11.1 General**

All monitoring, servicing and maintenance operations are to ensure correct functioning of the equipment; they must be effected with utmost care.

- Only “qualified persons” may do this work.
- Servicing and maintenance work must only be done when the hoist is not loaded.
- Records must be kept of all test results and measures taken.

### **11.2 Monitoring**

The monitoring and servicing intervals stated are valid for operation under normal conditions and single-shift operation. In case of severe operating conditions (e.g. frequent operation with full load) or special environmental conditions (e.g., heat, dust, etc.), the intervals must be shortened correspondingly

## 12 Inspection

### 12.1 Periodic checks

Independently from the regulations of the individual countries, HADEF lifting devices must be checked at least yearly by a qualified person or licensed qualified person regarding its functional safety.



In Germany it is necessary to observe the accident prevention regulations BGV D6, BGV D8, BGR 500 as well as DIN 15020 (Basics for cable drives). In other countries, the above mentioned tests and the national safety regulations apply.

### 12.2 Inspection intervals

|   | at<br>commissioning | Inspection<br>all 3 month | Inspection<br>all 12 month |
|---|---------------------|---------------------------|----------------------------|
| Screw connections                             | X                   |                           | X                          |
| Check socket pins and plugs                   | X                   |                           |                            |
| End stops                                     | X                   | X                         |                            |
| Inspection by an expert (periodic inspection) |                     |                           | X                          |

**13 Service**

**13.1 Slewing bracket**

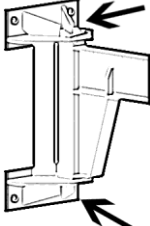
| Use      |  | Recommendation        |  | Intervals   |
|----------|---|-----------------------|---|---|
| Bearings |  | FUCHS<br>RENOLIT FEP2 | 0,5 kg  | 12 month<br><br>if bigger<br>pollution<br>grease all 3<br>month |

**13.2 Lubricant - Selection**

| FUCHS         | SHELL        | ESSO        | MOBIL        | TOTAL      | CASTROL               | KLÜBER               |
|---------------|--------------|-------------|--------------|------------|-----------------------|----------------------|
| Renolit FEP 2 | Alvania EP 2 | Unirex EP 2 | Mobilux EP 2 | MULTIS EP2 | --                    | --                   |
| Stabylan 5006 | --           | --          | --           | --         | Optimol Viscoleb 1500 | Klüberoil 4UH 1-1500 |

**13.3 Lubricant for food industry – Selection (as option\*)**

|  | SHELL         | MOBIL               | CASTROL               |
|--|---------------|---------------------|-----------------------|
| Gearing  | FM Grease HD2 | Mobilegrease FM 222 | --                    |
| Load chain                                       | --            | Lubricant FM 100    | Optimol Viscoleb 1500 |
| Load hook<br>Pulleys<br>Gear rim<br>Drive pinion | FM Grease HD2 | Mobilegrease FM 222 | --                    |

\* must be mentioned by order

### 14 Trouble

Please pay attention to the following in case of problems:

- Troubles with the equipment must only be repaired by qualified personnel.
- Secure the unit against unintended operation start.
- Put up a warning note indicating that the unit is not to be used.
- Secure the working area of moving parts of the unit.
- Please read the chapter "Safety instructions".

Notes on the repair of faults are found in the following table.

For the repair of failures please contact our service department.



#### **CAUTION!**

Trouble caused by wear or damage to parts such as wire ropes, chains, chain wheels, axes, bearings, brake parts, etc., must be remedied by replacing the parts with original spare parts.

**15 Remedy**

| Problem               | Cause                          | Remedy                                   |
|-----------------------|--------------------------------|--|
| Jib is hardly to slew | Bearings inhibited by overload | Maintain – change bearings               |
| Jib - deformed        | Overloaded                     | Check jib and bracket – if so, change it |

### 16 Decommissioning



#### **WARNING!**

It is essential that the following points are observed in order to prevent damage to the equipment or critical injury when the device is being decommissioned:

It is mandatory that all steps for decommissioning the machine are carried out in the indicated sequence:

- First secure the working area for decommissioning, leaving plenty of space.
- Read the chapter "Safety instructions".
- Disassembly is carried out in reverse order to the assembly.
- Please make sure that all operating material is disposed of in accordance with environmental regulations.

#### **16.1 Temporary decommissioning**

- Measures are as above.
- Also read the chapter "Transport and storage".

#### **16.2 Final decommissioning/disposal**

- Measures are as above.
- After disassembly, ensure that the disposal of the equipment and any materials it contains is carried out in accordance with environmental regulations.

## **17 Additional documents**

### **17.1 Operating instructions for cranes**

acc. to §§ 29-43 of the accident prevention regulations for "cranes" BGV D6 are attached to the consignment or to the documents.