



Installation,- Operating and Maintenance Instructions

HADEF Single Girder Manual Underslung Crane

Type EDHH

also available as adapter crane

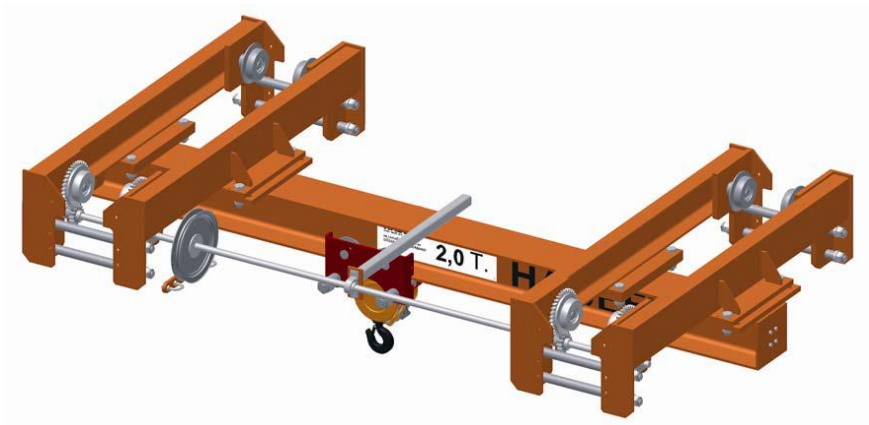

HADEF

Internet Download: www.doc.hadef.de/bedhh_gb.pdf

 **NOTE!**

The installation or mounting instructions for incomplete machines you'll find in chapter "Installation"

© by Heinrich de Fries GmbH

Heinrich de Fries GmbH, Gauss Str. 20, D-40235 Düsseldorf



Heinrich de Fries GmbH wird im Weiteren als HADEF bezeichnet.

Originalbetriebsanleitung in deutscher Sprache.

Eine Kopie kann bei HADEF schriftlich angefordert werden.

Änderungen vorbehalten.



Heinrich De Fries GmbH will be named HADEF in the following text.

Translation of the original operating and maintenance instructions

A copy is available from HADEF on request.

Subject to changes.

Table of Contents

1	Information	4
2	Safety	5
2.1	Warning notice and symbols.....	5
2.2	Duty of care of the owner.....	5
2.3	Requirements for the operating personnel	6
2.4	Appropriate use	6
2.5	Basic safety measures	7
2.1	Safety Instructions	7
3	Transport and Storage	8
3.1	Transport.....	8
3.2	Safety device for transport	8
3.3	Storage	8
4	Description	9
4.1	Areas of application	9
4.2	Design.....	9
4.3	Function description	10
4.4	Important Components	10
5	Technical data.....	11
6	Installation.....	12
6.1	Assembly - for complete cranes	12
6.2	Assembly – partially assembled cranes.....	13
6.3	Assembly – Adapter Cranes	13
6.4	Table of screws.....	14
6.5	Tools	14
7	Operation.....	15

8	Commissioning	16
8.1	General	16
8.2	Teeth of the drive	16
9	Safety check	17
10	Functional test.....	18
10.1	Checks before initial start-up.....	18
10.2	Functional test.....	18
11	Maintenance.....	19
11.1	General	19
11.2	Monitoring.....	19
12	Inspection	20
12.1	Periodic checks	20
12.2	Inspection intervals.....	20
13	Service.....	21
13.1	Crane trolley	21
13.2	Lubricant selection	21
14	Trouble	22
15	Remedy	23
16	Decommissioning	24
16.1	Temporary decommissioning	24
16.2	Final decommissioning/disposal.....	24
17	Additional documents.....	25
17.1	Operating instructions for cranes.....	25

1 Information

HADEF products meet European Union requirements, in particular the EU Machine Directive (2006/42/EG).

The entire company works acc. to a certified quality assurance system as per ISO 9001.

The production of components at HADEF is subject to strict, intermediate checks.

After assembly, each HADEF product is subject to a final test with overload.

For the operation of hoists, the accident prevention regulations BGV D8, BGV D6 and BGR 500 apply in Germany, amongst others.

The stated performance of the devices and meeting any warranty claims require adherence to all instructions in this manual.

Before delivery, all HADEF products are packed properly. Check the goods after receipt for any damage caused during transport. Report any damage immediately to the forwarding agent.

This manual allows a safe and efficient use of equipment. Images of this manual are for a principle understanding and can be different from the real design.

NOTE!

We refer to the prescribed equipment tests before initial start-up, before putting back into operation and the regular periodic inspections.

In other countries any additional national regulations must be observed.

2 Safety

2.1 Warning notice and symbols

Warnings and notice are shown as follows in these instructions:

 DANGER!	This means that there is a high risk that leads, if it is not avoided, to death or severe injury.
--	---

 WARNING!	This means that there is a risk that could lead, if it is not avoided, to death or severe injury.
---	---

 CAUTION!	This means that there is little risk that could lead, if it is not avoided, to slight injury or damage to the device or its surrounding.
---	--

 **NOTICE!** Gives advice for use and other useful information.

 Danger from electricity.

 Danger from explosive area.

2.2 Duty of care of the owner

The unit was designed and built following a risk analysis and careful selection of the harmonized standards that are to be complied with, as well as other technical specifications. It therefore represents state-of-the-art technology and provides the highest degree of safety.

Our delivery includes the hoist supplied beginning at its suspension and ending at the load hook and if supplied with control, the control line/hose that leads to the hoist. Further operating material, tools, load attaching devices as well as main energy supply lines must be assembled according to the valid rules and regulations. For explosion-proof equipment, all these parts must be approved for use in area prone to explosion, or they must be suitable for use in area prone to explosion. The owner is responsible for this.

However, in everyday operation this degree of safety can only be achieved if all measures required are taken. It falls within the duty of care of the owner/user of the devices to plan these measures and to check that they are being complied with.

Complete the operating and installation instructions by any instructions (regarding supervision or notifications) that are important for the special kind of use of the equipment, i.e. regarding organization of work, work flow and human resources.

In particular, the owner/user must ensure that:

- The unit is only used appropriately.
- The device is only operated in a fault-free, fully functional condition, and the safety components, in particular, are checked regularly to ensure that it is functioning properly.
- The required personal protective equipment for the operators, service and repair personnel is available and is used.
- The operating instructions are always available at the location where the equipment is used and that they are legible and complete.
- The unit is only operated, serviced and repaired by qualified and authorized personnel.
- This personnel is regularly trained in all applicable matters regarding safety at work and environmental protection, and that they are familiar with the operating manual and, in particular, the safety instructions it contains.
- Any safety and warning signs on the devices are not removed and remain legible.
- Devices for use in area prone to explosion must (from customer's side) be earthed with a shunting resistor of $< 10^6 \Omega$ against earth.

 WARNING!
It is not allowed to make constructive changes of the equipment!

2.3 Requirements for the operating personnel

The units may only be operated by qualified persons that are appropriately trained and that are familiar with it. They must have their employer's authorisation for operation of the units.

Before starting work, the operating personnel must have read the operating and installation instructions, especially the chapter "Safety Instructions".

This is especially important for operating personnel that rarely uses the equipment, i.e. for installation or maintenance work.



DANGER!

In order to avoid severe injury, please pay attention to the following when using the equipment:

- Use protective clothes/equipment.
- Do not wear long hair hanging down open.
- Do not wear rings or other jewellery.
- Do not wear cloths that are too big/wide.

2.4 Appropriate use

Appropriate use of the crane is horizontal movement of loads in direction of the beam and crane runway. The cranes can be used with suitable lifting gears.

Please observe the separate operating manual for the hoist.

The permitted safe working load of the devices must not be exceeded! An exception can be made during the load test, carried out by a licensed expert in accordance with the accident prevention regulations UVV BGV D6 before initial operation.

- The permitted environmental temperature during equipment operation is -20°C to $+40^{\circ}\text{C}$.
- The standard equipment is made for indoor use. For outdoor use we recommend a weather protection paint and protection covers to protect the hoists. For electric equipment, the electric control lines and electric devices must also be protected. Higher protection classes are also recommended for outdoor use.
- Defective devices and load suspension devices must not be used until they have been repaired! Only original HADEF spare parts must be used. Non-compliance will result in any warranty claims on HADEF becoming void.
- Liability and warranty will become void if unauthorized modifications of the units are made by the user!



NOTE!

If the units are not used appropriately, it is not possible to ensure safe operation.

The owner and operator have sole liability for all personal injury and damage to property arising from inappropriate use.



DANGER!

It is not allowed:



- pulling loose of stuck loads, dragging of loads and inclined pulling is not allowed.
- in explosive atmosphere, except the unit is especially modified for it and marked by an indication label
- to transport people
- persons must not stand under a suspended load

2.5 Basic safety measures

- Only use the hoists appropriately.
- Never load the devices beyond their permitted working load limit.
- Please observe the accident prevention regulations (UVV).
- Should the equipment be used outside of Germany, please pay attention to the national regulations that apply.
- Grounds and supporting structures used in conjunction with this equipment must provide an adequate stability. In case of doubt, please consult a structural engineer.
- If the equipment has not been used for a period of time, carry out visual checks of all main components and replace any damaged parts with new, original spare parts.
- Please pay attention to the regulations for load carrying devices UVV BGR 500 for both positive and non-positive methods of attaching loads.
- Do not use defective equipment.
- Any damage and faults must be reported to a responsible supervisor immediately.
- If the unit is put into motion, any persons in the immediate vicinity must be informed by calling to them!
- Load-attaching devices must be in perfect shape.
- The load must not bump against the crane construction.

2.1 Safety Instructions

Please pay attention to the following additional safety instructions to prevent injury:

	 DANGER!
It is not permitted to use the unit in an area at risk from explosion!	

- Please pay attention to the operating and maintenance instructions.
- Please pay attention to the operating and maintenance instructions of the hoists.
- Please pay attention to the warnings mentioned on the device.
- Please consider oscillations of the load and the stopping distance.
- Please adhere the safe distances.
- Please insure good sight during operation.
- In case of trouble stop operation immediately and eliminate the defect.

3 Transport and Storage



CAUTION!

Transport may only be done by qualified personnel. No liability for any damage resulting from improper transport or improper storage.

3.1 Transport

HADEF devices are checked and if so adequately packed before delivery.

- Do not throw or drop the equipment.
- Use adequate means of transport.

Transport and means of transport must be suitable for the local conditions.

3.2 Safety device for transport



NOTE!

Should a safety device for transport exist, please remove it before commissioning.

3.3 Storage

- Store the equipment at a clean and dry place.
- Protect the equipment against dirt, humidity and damage by an appropriate cover.
- Protect hooks, wire ropes, chains and brakes against corrosion.



4 Description

4.1 Areas of application

The devices must be as far as possible installed in a covered room.

If they are used in the open, protect the units against the effects of weather such as rain, hail, snow, direct sunshine, dust, etc. - we recommend to use a cover in parking position. If the device is set up in a continuously humid environment with strong temperature fluctuations, the correct functioning of the motor and the brake are endangered by the forming of condensation.

Ambient temperature: - 20°C up to + 40°C. Humidity: 100 % or less but not under water

	 DANGER!
It is not permitted to use the unit in an area at risk from explosion!	

4.2 Design

HADEF Single girder manual underslung cranes can be used with any type of HADEF hoists combined with trolley.

According to DIN 15018

Electric and pneumatic cranes according to H2/B3

Manual cranes according to H1/B2

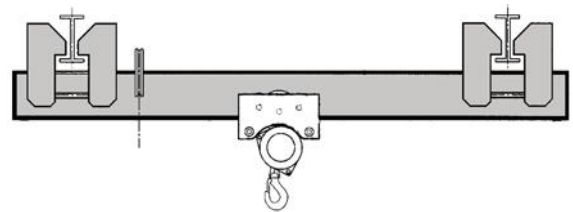

Illustration 1

Version C

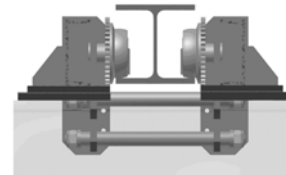

Illustration 2

Version A

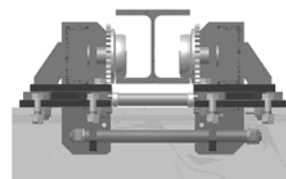

Illustration 3

As standard, the cranes are supplied with welded end carriages, version „C“.

Optionally the screwable version „A“ can be taken to assemble the end carriages should this be more advantageous.

4.2.1 Adapter Cranes

Adapter cranes are supplied without main beam.

The main beam can be bought nearby the site and assembled there which reduces costs for transport.

The end carriages are available in two versions - with screw fittings or weldable.

4.3 Function description

Movement direction

- 1 manually trolley drive
- 2 manually crane drive
- 3 manually lifting and lowering

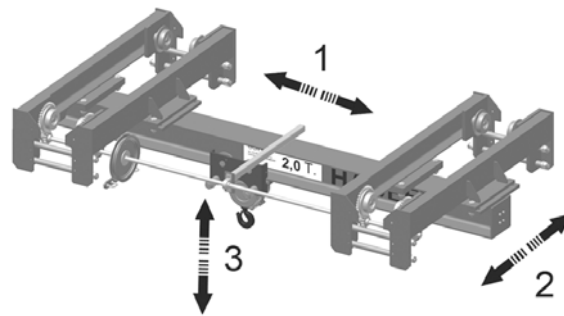

Illustration 4

4.4 Important Components

4.4.1 Main beam

Profile main beam

4.4.2 End carriage

Structural tubing shape including running wheels and travel drive

Standard as welded version „C“

As option available screw fittings, version „A“

4.4.3 Wheels

Machined steel wheels with ball bearing and wheel flange

5 Technical data

Capacity	Span up to	Wheel base	Wheel Ø	Max. wheel load with hoist 24/98 HH	Max. wheel load with hoist 29/98 HH	Travel path when reeling off 30 m of hand chain	Hand chain pull	Weight *
kg	mm	mm	mm	kg	kg	m	kg	kg
1000	7000	1200	120	657	672	5	2	703
	10000	1200	120	794	809	5	2,5	1195
	14000	1600	150	1029	1044	5,2	3,5	2101
1500	7000	1200	120	918	943	5	2,5	776
	10000	1200	120	1068	1093	5	3	1296
	14000	1600	150	1373	1398	5,2	4,5	2464
2000	7000	1200	120	1168	1196	5	3	851
	10000	1200	120	1331	1359	5	3,7	1402
	14000	1600	150	1615	1643	5,2	4,8	2464
3000	7000	1600	150	1683	1724	5,2	4,3	1004
	10000	1600	150	1877	1918	5,2	5	1615
	14000	1600	150	2163	2204	5,2	6	2654
5000	6000	1600	150	2578	2652	5,2	6,4	929
	10000	1600	150	2887	2961	5,2	7,3	1791
	14000	2000	200	3279	3353	5,9	10,3	3178
10000	7000	2000	200	5209	5618	5,9	15	1935
	10000	2000	200	5523	5932	5,9	16	2634
	14000	2000	250	5951	6360	7,8	14	3974

*Weight without lifting unit and standard profile

Listed data are standards. Intermediate sizes possible.

Find order-related data on type plates of the crane and lifting unit.

6 Installation

Assembly depends on the local environment. The crane must be assembled stress-free. The runway must be perfect.

Operating regulations for cranes in accordance with §§ 29-43 of the accident prevention regulations "cranes" BGV D6.

There must be end stops (provided by the customer) on both ends of the crane runway.

They must be attached so that the rubber buffers or the trolley wheels drive against them in their end position.

Generally, additional lifting gear (e.g. fork lift, lifting platforms) will be required for the assembly. These must take the weight of the devices safely.

6.1 Assembly - for complete cranes

The crane is fully assembled and installed, including the hoist and power supply for the electric version.

Prepare crane for proper and safe transport with a truck-mounted crane, on the ground

Consider two different procedure for assembly for the different running wheel diameters

Find suitable running wheel diameters in the crane test book

For electric cranes the customer must effect electric wiring according to the rules and regulations

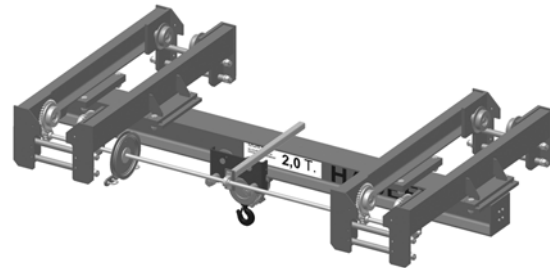

Illustration 5

Assembly up to wheel diameter 150 mm

- Lift up the crane by suitable lifting hoist
- Loose fixing screws of end carriage (2)
- Loose the screws of the connection bolts (10) only at one side
- Slotted holes (9) are provided for pulling the end carriage halves apart; push the running wheels (5) on the lower flanges of the crane travelling beam
- Push the end carriage halves together again
- Adjust the end carriage halves into the correct position (2) by pin through the provided bores
- Tighten the screws of end carriages

Assembly from wheel diameter 200 mm

- Remove the bolted endplates (6)
- Loose pin locks (8) and wheels (5) and remove wheel axles (7)
- Lift up the crane bridge up to the wheels (5) are in position over the lower flanges of crane rail beam
- Assemble the wheels (5); put through the wheel axles (7) and secure by pin locks (8) again

- Set up the crane bridge; the running wheels must be bear on the lower flanges of crane rail beam
- Slow test drive without load about the whole distance of crane rail way; check proper drive
- Pay attention of interfering edges and a correct drive without barriers; check proper position of crane end stops

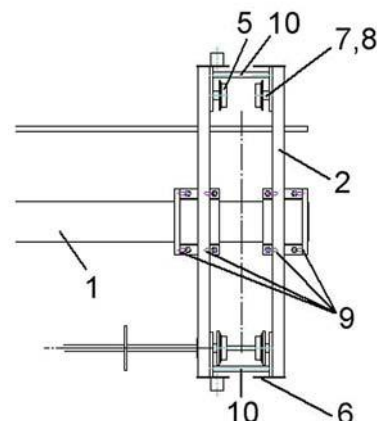

Illustration 6

6.2 Assembly – partially assembled cranes

The crane is, apart from the hoist, fully assembled and installed, incl. power supply for electric cranes.

- Install the hoist according to its operation instruction
- Assemble electric cranes according to the wiring diagram
- Proceed assembly as mentioned before the complete crane

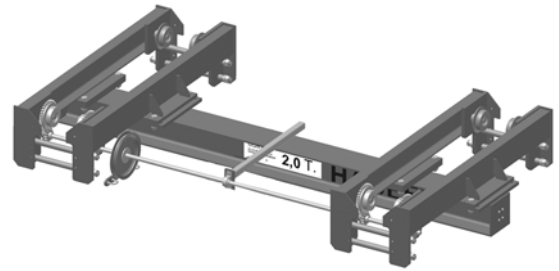

Illustration 7

6.3 Assembly – Adapter Cranes

Scope of supply:

- 1 set end carriages
- 1 set adapter plates with screw fittings including, optionally
- 1 set weldable adapter plates



Illustration 8

Connection A

- bore main beam acc. former plate
- Install end carriages at the main beam with attached fixing screws. Tightening torque acc. table.
- secure with safety nuts
- check all screw connections

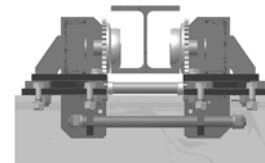

Illustration 9

Connection C

- weld-on the adapter plates onto the main beam
- weld the end carriages onto the main beam

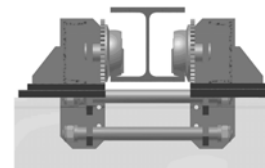

Illustration 10

NOTE!

Welding at crane components must be done only by a certified welder. (acc. DIN 18800)

6.4 Table of screws



Tighten the screws with tightening moment mentioned in the table

Thread	Tightening moment (Nm) in property class	
	8.8	10.9
M 6	10,4	15,3
M 8	25,3	37,2
M 10	51	75
M 12	87	128
M 14	139	205
M 16	214	314
M 18	280	390
M 20	431	615
M 22	530	750
M 24	742	1159
M 27	1000	1400
M 30	1350	1900
M 33	2000	2800

coefficient of friction 0,12 - 0,14 μ ges

6.5 Tools

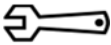
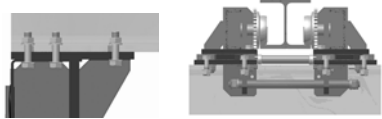
Special tools are not required.

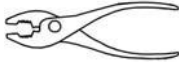
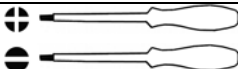
Size	Tool	Use	
misc.		Adapter assembly	
			
			
misc.			

7 Operation

Only people that are familiar with the operation of the lifting devices and cranes may be entrusted with their operation. They must be authorized by the employer for the operation of the equipment. The employer must ensure that the operating instructions are available near the equipment and that they are accessible for the operating personnel.

Movement of the crane by endless hand chain
pulling the chain fall 1 = movement direction 1
pulling the chain fall 2 = movement direction 2

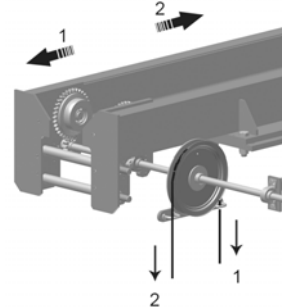

Illustration 11

8 Commissioning

8.1 General

Should the unit be used in Germany, please observe the accident prevention regulations, in particular BGV D8, BGV D 6 and BGR 500 (VBG 9a).

For other countries: Inspections as above. Please observe the national rules and regulations and the instructions in this manual!

NOTE!

Hoists up to 1000 kg capacity and without motor-driven trolleys of hoisting unit must be tested by a “qualified person” before putting into operation for the first time.

Hoists of 1000 kg capacity and up or with more than one motor-driven hoist movement; i.e. lifting and trolley movement, must be tested by a “licensed quality person” before putting in operation.

An exception is “hoists ready for operation” acc. To BGV D6 II§25(4) with EU-declaration of conformity.

Definition “qualified person” (former expert)

A “qualified person” has learned, due to occupational training and experience and the job that the person has done, the skills needed to tests the material for one’s work.

Definition “licensed qualified person” (former approved expert)

A “licensed qualified person” has, due through special occupational training, knowledge about testing of the material for one’s work and knows the national accident prevention regulations and other prescriptions and technical regulations. This person must test the material for one’s work regularly with regard to design and kind of use. The license will be given to qualified person be the approved supervision authorities (ZÜS).

8.2 Teeth of the drive

The teeth of the drive must be lubricated before putting the equipment into operation.

9 Safety check

Before putting into service initially or when putting back into service, it must be checked whether:

- All fastening screws (if existent), socket pins, flap socket and safety devices are tightened and secured.

10 Functional test

10.1 Checks before initial start-up

Design

- Check all screws and safety connections
- The open-lying teeth of the crane trolley must be lubricated.

10.2 Functional test

Function - crane trolley

- Check properly running of the crane.
- Check the beam for obstacle-free running.
- Carefully move the crane to the end positions and check the positions of the end stops.

11 Maintenance

11.1 General

All monitoring, servicing and maintenance operations are to ensure correct functioning of the equipment; they must be effected with utmost care.

- Only “qualified persons” may do this work.
- Servicing and maintenance work must only be done when the hoist is not loaded.
- Records must be kept of all test results and measures taken.

11.2 Monitoring

The monitoring and servicing intervals stated are valid for operation under normal conditions and single-shift operation. In case of severe operating conditions (e.g. frequent operation with full load) or special environmental conditions (e.g., heat, dust, etc.), the intervals must be shortened correspondingly

12 Inspection

12.1 Periodic checks

Independently from the regulations of the individual countries, HADEF lifting devices must be checked at least yearly by a qualified person or licensed qualified person regarding its functional safety.

In Germany it is necessary to observe the accident prevention regulations BGV D6, BGV D8, BGR 500 as well as DIN 15020 (Basics for cable drives). In other countries, the above mentioned tests and the national safety regulations apply.



12.2 Inspection intervals

	at putting into operation	daily checks	Inspection every 3 months	Inspection every 12 months
Check screw connections.	X			X
check socket pins and plugs	X			
Check the wheels for wear				X
Check the function of the brake (electric and pneumatic cranes)	X	X		
lubricate the teeth of the wheels			X	
Gear	see chapter "maintenance"			
inspection of the equipment by an expert (periodic inspection)				X

13 Service

13.1 Crane trolley

- Lubricate the teeth of the trolley wheels with grease every 3 month or more often if required

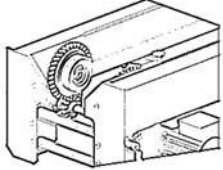
Use		Recommendation		Intervals
teeth of trolley wheels driving pinion		FUCHS RENOLIT FEP2	1 kg	3 month

13.2 Lubricant selection

FUCHS	SHELL	ESSO	ARAL	MOBIL	KLÜBER
Renolit FEP 2	Alvania EP 2	Unirex EP 2	--	Mobilux EP 2	--

14 Trouble

Please pay attention to the following in case of problems:

- Troubles with the equipment must only be repaired by qualified personnel.
- Secure the unit against unintended operation start.
- Put up a warning note indicating that the unit is not to be used.
- Secure the working area of moving parts of the unit.
- Please read the chapter "Safety instructions".

Notes on the repair of faults are found in the following table.

For the repair of failures please contact our service department.



CAUTION!

Trouble caused by wear or damage to parts such as wire ropes, chains, chain wheels, axes, bearings, brake parts, etc., must be remedied by replacing the parts with original spare parts.

15 Remedy

Problem	Cause	Remedy
Trolley is hardly to travel	Obstacle on the beam Deformation in the construction	Remove the obstacle Examine the crane, have it repaired by an authorised workshop if necessary

16 Decommissioning



WARNING!

It is essential that the following points are observed in order to prevent damage to the equipment or critical injury when the device is being decommissioned:

It is mandatory that all steps for decommissioning the machine are carried out in the indicated sequence:

- First secure the working area for decommissioning, leaving plenty of space.
- Read the chapter "Safety instructions".
- Disassembly is carried out in reverse order to the assembly.
- Please make sure that all operating material is disposed of in accordance with environmental regulations.

16.1 Temporary decommissioning

- Measures are as above.
- Also read the chapter "Transport and storage".

16.2 Final decommissioning/disposal

- Measures are as above.
- After disassembly, ensure that the disposal of the equipment and any materials it contains is carried out in accordance with environmental regulations.

17 Additional documents

17.1 Operating instructions for cranes

acc. to §§ 29-43 of the accident prevention regulations for "cranes" BGV D6 are attached to the consignment or to the documents.