



# Installation,- Operating and Maintenance Instructions

## HADEF Pneumatic Chain Hoist

### Type 70/06AP

stationary with suspension eye  
with monorail push travel trolley  
with monorail hand geared trolley  
with monorail pneumatic trolley

APS  
APR  
APH  
APP



**HADEF**

 **NOTICE!**

The installation or mounting instructions for incomplete machines you'll find in chapter "Installation"

© by Heinrich de Fries GmbH

Heinrich de Fries GmbH, Gauss Str. 20, D-40235 Düsseldorf

Heinrich De Fries GmbH will be named HADEF in the following text.

Original operating- and maintenance instructions in German language.

Translation in other languages is made of the German original.

A copy may be requested in writing or is available for download on [www.hadef.com](http://www.hadef.com)

Subject to changes.

## Table of Contents

<b>1</b>	<b>Information.....</b>	<b>3</b>
1.1	Indications to determine the used part of the theoretical usage life.....	4
<b>2</b>	<b>Safety .....</b>	<b>4</b>
2.1	Warning notice and symbols .....	4
2.2	Duty of care of the owner .....	4
2.3	Requirements for the operating personnel .....	5
2.4	Appropriate use .....	5
2.5	Basic safety measures .....	6
<b>3</b>	<b>Transport and Storage .....</b>	<b>7</b>
3.1	Transport.....	7
3.2	Safety device for transport.....	7
3.3	Storage .....	7
<b>4</b>	<b>Description.....</b>	<b>7</b>
4.1	Areas of application.....	7
4.2	Design .....	8
4.3	Functions .....	8
4.4	Important components .....	9
<b>5</b>	<b>Technical data .....</b>	<b>10</b>
<b>6</b>	<b>Installation .....</b>	<b>11</b>
6.1	Stationary hoist AKS + APS .....	11
6.2	Trolley.....	12
6.3	Assembly on the beam AK+AP 402 to AK+AP 912.....	13
6.4	Assembly on the beam AK+AP 915 - 930, AK+AP1010 - 1025 .....	14
6.5	Tools.....	15
<b>7</b>	<b>Operation .....</b>	<b>15</b>
<b>8</b>	<b>Operation .....</b>	<b>16</b>
<b>9</b>	<b>Commissioning .....</b>	<b>17</b>
9.1	General .....	17
9.2	Compressed air connection.....	17
9.3	Gear .....	18
9.4	Load chain.....	18

<b>10</b>	<b>Safety check .....</b>	<b>18</b>
<b>11</b>	<b>Functional test.....</b>	<b>19</b>
11.1	Checks before the initial start-up .....	19
11.2	Functional test .....	19
<b>12</b>	<b>Maintenance .....</b>	<b>19</b>
12.1	General .....	19
12.2	Monitoring .....	19
12.3	Replacing the load chain.....	19
12.4	Pneumatic motor .....	21
12.5	Overload protection.....	21
<b>13</b>	<b>Inspection .....</b>	<b>22</b>
13.1	General Overhaul for motor-driven units .....	22
13.2	Periodic checks .....	22
13.3	Checking the load chain.....	22
13.4	Checking the load hook .....	23
13.5	Inspection – Gear – Oil level .....	24
<b>14</b>	<b>Service .....</b>	<b>24</b>
14.1	Load chain.....	24
14.2	Pulleys.....	24
14.3	Load hook .....	25
14.4	Hoist gear .....	25
14.5	Trolley.....	26
14.6	Pneumatic motor .....	26
14.7	Lubricant selection.....	27
14.8	Lubricant for food industry – selection (as option*) .....	27
<b>15</b>	<b>Trouble.....</b>	<b>27</b>
<b>16</b>	<b>Remedy .....</b>	<b>28</b>
<b>17</b>	<b>Decommissioning .....</b>	<b>29</b>
17.1	Temporary decommissioning.....	29
17.2	Final decommissioning/disposal.....	29
<b>18</b>	<b>Additional documents.....</b>	<b>29</b>
18.1	Pneumatic connections diagram.....	29

## **1 Information**

The products meet European Union requirements, in particular the validated EU Machine Directive.

The entire company works acc. to a certified quality assurance system as per ISO 9001.

The production of components at our work is subject to strict, intermediate checks.

After assembly, each product is subject to a final test with overload.

For the operation of hoists, the national accident prevention regulations apply in Germany, amongst others.

The stated performance of the devices and meeting any warranty claims require adherence to all instructions in this manual.

Before delivery, all products are packed properly. Check the goods after receipt for any damage caused during transport. Report any damage immediately to the forwarding agent.

This manual allows a safe and efficiently use of equipment. Images of this manual are for a principle understanding and can be different from the real design.

 **NOTICE!**

We refer to the prescribed equipment tests before initial start-up, before putting back into operation and the regular periodic inspections.

In other countries any additional national regulations must be observed.

**1.1 Indications to determine the used part of the theoretical usage life.**

For motor driven units.

The equipment (rope hoists, chain hoists, winches as well as crane hoisting units) are classified in drive groups (duty classification) according to their intended mode of operation, running times and load collectives and dimensioned according to the requirements derived from these.

They are thus only designed for a limited period of use with regard to the overall dimensioning and certification.



After the total period of use as elapsed, measures must be taken where parts are checked and exchanged as per indication by the manufacturer. After that a new maximum usage period is determined. See also the valued accident prevention regulations, "winches, lifting and pulling devices".



 **NOTICE!****Commitment**

A general overhaul may only be performed by HADEF or by a specialized company, authorized by HADEF.

**2 Safety****2.1 Warning notice and symbols**

Warnings and notice are shown as follows in these instructions:

 <b>DANGER!</b>	This means that there is a high risk that leads, if it is not avoided, to death or severe injury.
 <b>WARNING!</b>	This means that there is a risk that could lead, if it is not avoided, to death or severe injury.
 <b>CAUTION!</b>	This means that there is little risk that could lead, if it is not avoided, to slight injury or damage to the device or its surrounding.

 **NOTICE!** Gives advice for use and other useful information. Danger from electricity. Danger from explosive area.**2.2 Duty of care of the owner**

 <b>DANGER!</b>
Failure to follow the instructions of this manual can lead to unpredictable hazards. For any resulting damage or personal injury, HADEF assumes no liability.

The unit was designed and built following a risk analysis and careful selection of the harmonized standards that are to be complied with, as well as other technical specifications. It therefore represents state-of-the-art technology and provides the highest degree of safety.

Our delivery includes the hoist supplied beginning at its suspension and ending at the load hook and if supplied with control, the control line/hose that leads to the hoist. Further operating material, tools, load attaching devices as well as main energy supply lines must be assembled according to the valid rules and regulations. For explosion-proof equipment, all these parts must be approved for use in area prone to explosion, or they must be suitable for use in area prone to explosion. The owner is responsible for this.

However, in everyday operation this degree of safety can only be achieved if all measures required are taken. It falls within the duty of care of the owner/user of the devices to plan these measures and to check that they are being complied with.

Complete the operating and installation instructions by any instructions (regarding supervision or notifications) that are important for the special kind of use of the equipment, i.e. regarding organization of work, work flow and human resources.

In particular, the owner/user must ensure that:

- The unit is only used appropriately.
- The device is only operated in a fault-free, fully functional condition, and the safety components, in particular, are checked regularly to ensure that it is functioning properly.
- The required personal protective equipment for the operators, service and repair personnel is available and is used.
- The operating instructions are always available at the location where the equipment is used and that they are legible and complete.
- The unit is only operated, serviced and repaired by qualified and authorized personnel.
- This personnel is regularly trained in all applicable matters regarding safety at work and environmental protection, and that they are familiar with the operating manual and, in particular, the safety instructions it contains.
- Any safety and warning signs on the devices are not removed and remain legible.
- Devices for use in area prone to explosion must (from customer's side) be earthed with a shunting resistor of  $< 10^6 \Omega$  against earth.



## **WARNING!**

It is not allowed to make constructive changes of the equipment!

### **2.3 Requirements for the operating personnel**

The units may only be operated by qualified persons that are appropriately trained and that are familiar with it. They must have their employer's authorisation for operation of the units.

Before starting work, the operating personnel must have read the operating and installation instructions, especially the chapter "Safety Instructions".

This is especially important for operating personnel that rarely uses the equipment, i.e. for installation or maintenance work.



## **DANGER!**

In order to avoid severe injury, please pay attention to the following when using the equipment:

- Use protective clothes/equipment.
- Do not wear long hair hanging down open.
- Do not wear rings or other jewellery.
- Do not wear clothes that are too big/wide.

### **2.4 Appropriate use**

The permitted safe working load of the devices must not be exceeded! An exception can be made during the load test before initial operation, carried out by a licensed qualified person.

- The permissible ambient temperature during operation of manual driven devices is  $-20^{\circ} \text{C} / +50^{\circ} \text{C}$  and at all power driven devices  $-20^{\circ} \text{C} / +40^{\circ} \text{C}$ !
- Defective devices and load suspension devices must not be used until they have been repaired! Only original spare parts must be used. Non-compliance will result in any warranty claims becoming void.
- Liability and warranty will become void if unauthorized modifications of the units are made by the user!

The appropriate use of the hoists is vertical lifting and lowering of unguided loads. In combination with trolleys, loads can also be moved horizontally.

**DANGER!**

It is not allowed:

- pulling loose of stuck loads, dragging of loads and inclined pulling is not allowed.
- in explosive atmosphere, except the unit is especially modified for it and marked by an indication label
- to transport people
- The device is not suitable for use on stages and in studios
- persons must not stand under a suspended load

**NOTICE!**

If the units are not used appropriately, it is not possible to ensure safe operation.

The owner and operator have sole liability for all personal injury and damage to property arising from inappropriate use.

## 2.5 Basic safety measures

- Observe installation-, operation and maintenance instruction.
- Take notice of caution notes at units and in the manual
- Observe safety distances.
- Take care for a free view on the load.
- Only use the hoists appropriately.
- The equipment is to be used exclusively for movement of goods. Under no circumstances may persons be moved.
- Never load the devices beyond their working load limit.
- Pay attention to the accident prevention regulations (UVV).
- Should the hoist be used outside of Germany, please pay attention to the national regulations that apply.
- Supporting structures and load-attached devices used in conjunction with this equipment must provide an adequate safety factor to handle the rated load plus the weight of the equipment. In case of doubt, consult a structural engineer.
- If the equipment has not been used for a period of time, carry out visual checks of all main components such as chains, load hooks etc. and replace any damaged parts with new, original spare parts before putting the equipment back into operation!
- Do not use a hoist that is defective, pay attention to any abnormal noise it makes during operation.
- Stop working immediately in case of disturbances and remedy failures.
- Any damage and faults must be reported to a responsible supervisor immediately.
- If the unit is put into motion, any persons in the immediate vicinity must be informed by calling to them!
- Please pay attention to the regulations for load carrying devices UVV for both positive and non-positive methods of attaching loads.
- The lifting tackle or the load must be securely attached to the hook and be seated at the bottom of the hook.
- The safety catch of hooks must be closed.
- When charged, the housing may not be in contact somewhere.
- Stop lowering the load when the bottom block or the load is being set down or is prevented from being lowered further.
- The load chain must not be twisted.
- Twisted chains must be aligned before attaching the load.
- The correct alignment of the chain links can be seen from the weld seams.
- The chain links must always be aligned in one direction.

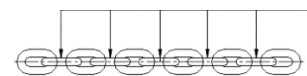

Illustration 1

 **NOTICE!**

Pneumatic air motors are capable of operating at continuous duty up to 100% and 360 cycles per hour and can be used in accordance with their device classification (mechanism class). The remaining service life of the devices in accordance with mechanism group and usage (see calculation of remaining service life) must be followed.

 **WARNING!**

The following is not allowed:

- to lift another load than the nominal safe working load
- to manipulate the sliding clutch if units are equipped with
- The use of elongated or damaged chains or wire ropes. Replace them immediately by new, original parts.
- Never loop the load chain around a load nor place or pull the chain over edges.
- Never repair damaged load hooks (e.g. by hammering), but replace them by original hooks.

### 3 Transport and Storage

 **CAUTION!**

Transport may only be done by qualified personnel. No liability for any damage resulting from improper transport or improper storage.

#### 3.1 Transport

The devices are checked and if so adequately packed before delivery.

- Do not throw or drop the equipment.
- Use adequate means of transport.

Transport and means of transport must be suitable for the local conditions.

#### 3.2 Safety device for transport

 **NOTICE!**

Should a safety device for transport exist, please remove it before commissioning.

#### 3.3 Storage

- Store the equipment at a clean and dry place.
- Protect the equipment against dirt, humidity and damage by an appropriate cover.
- Protect hooks, wire ropes, chains and brakes against corrosion.

## 4 Description

### 4.1 Areas of application



The devices must be as far as possible installed in a covered room.

If they are used in the open, protect the units against the effects of weather such as rain, hail, snow, direct sunshine, dust, etc. - we recommend to use a cover in parking position. If the device is set up in a continuously humid environment with strong temperature fluctuations, the correct functionings are endangered by the forming of condensation.

Ambient temperature -20°C up to +50°C. Power-operated units -20 up to +40°C. Humidity 100 % or less but not under water

During longer periods of standstill, corrosion may reduce the function of the brake.



 <b>DANGER!</b>
 <p>HADEF hoists, in their standard version, are not approved for use in areas that are prone to explosion.</p> <p>HADEF supplies special explosion-proof equipment for this purpose which has special EX-name plates on it stating the EX-classification.</p>

**4.2 Design**

HADEF pneumatic chain hoists are equipped with a suspension eye for stationary use. The one and two chain fall devices may optionally be equipped with a suspension hook.

All devices can also be supplied with monorail trolley with push travel, hand geared or electric drive.

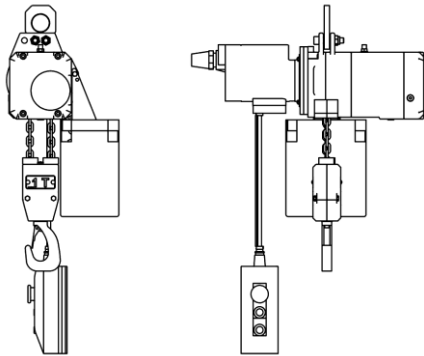

Type 70/06 APS, stationary

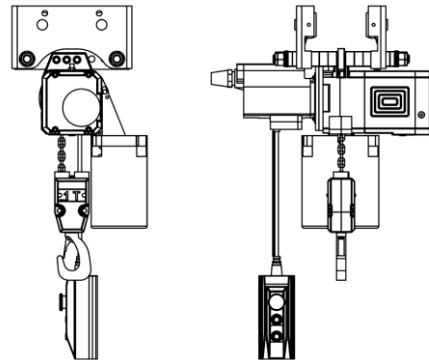

Type 70/06 APR, with push travel trolley

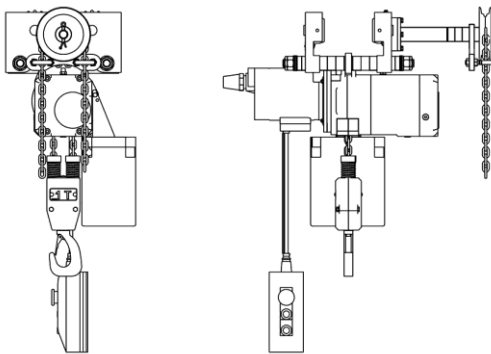

Type 70/06 APH, with geared travel trolley

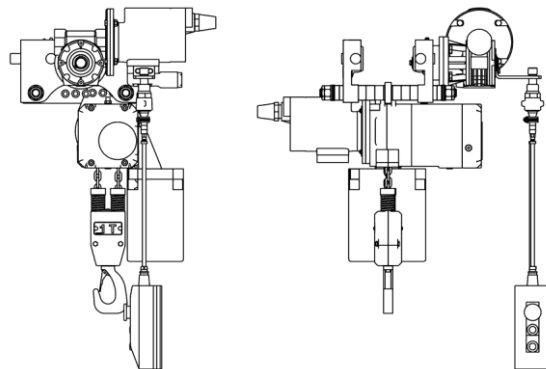

Type 70/06 APP, with pneumatic trolley

**4.3 Functions**

The lifting gear and motor-driven trolleys are moved by pressing the buttons on the control switch. The spring-operated brake which is integrated in the lifting motor prevents the load from being lowered automatically after releasing the control keys.

Hand geared trolleys are moved to the left or right by pulling one of the two stands of the endless hand chain.

 **NOTICE!**

The best protection against functional failures in case of extreme environmental impact is the regular use of the equipment.

If the hoist is not used very often, we recommend to carry out a test run at least once a week and to switch on the motor several times during this test run.

In our experience, this will prevent the brake from sticking.



## 4.4 Important components

### NOTICE!

All hoists are fitted with high-quality lifting gears of the reliable AK series.

#### 4.4.1 Motor

	Type of chain hoist
Pneumatic motor	70/06AP, 70/06AP-EX 28/06AP, 28/06 AP-EX 29/06AP, 29/06AP-EX 29/06APL Big Bag, 29/06APL Big Bag-EX

#### 4.4.2 Gear

##### Lifting gear with ventilation screw

AK 4-8 Precision Spur Gear

AK9+10 Precision Planetary Gear

##### Trolley gear

Combination of worm gear and motor

Closed design - ventilation not necessary.

#### 4.4.3 Control

Control switch with emergency stop

Classification of control according to lifting gear sizes

Kind of control	Standard	Option
Direct control	AK 4-6 (up to 1000 kg)	
Indirect control	AK 6-10 (from 1600 kg up)	AK 4-6 (up to 1000 kg)

#### 4.4.4 Overload protection

Type	Slipping clutch	mechanical stop by spring assembly		Pressure reducing valve	
		Standard	Option	Standard	Option
70/06AP+EX	AK 4-8	AK 9+10			AK 4-10
28/06AP+EX	AK 4-8		AK 4-10	AK 9+10	
29/06AP+EX	AK 4-8		AK 4-10	AK 9+10	

#### 4.4.5 Load chain

acc. to EN 818-7-T high quality chain

#### 4.4.6 Load hook

Hook in ball bearing with safety catch.

#### 4.4.7 Chain container

According to hoist type made of coated fabric, plastic or steel plate.

#### 4.4.8 Safety end switch (lifting/lowering)

automatic stop when the load chain does not run correctly

(only applicable for hoists with tensioning device)

#### 4.4.9 Maintenance unit (option)

for preparation of the operation air

#### 4.4.10 Emergency ventilation - hoisting motor (option)

Manual emergency opening for the brake via lever (A) to lower the load in case of drop of air pressure

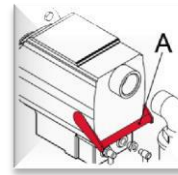

Illustration 2

#### 4.4.11 Operation limit switch

operational driving into upper and lower hook position (only for indirect control)

#### 4.4.12 Special components

only for hoists that are used in area at risk of explosion

## 5 Technical data

Table 1

Capacity/ number of falls  kg	Type	Speed  lifting  m/min	Speed  lowering  m/min	FEM 9.511/ ISO 4301	Motor output  kW	Air con- sumption  m3/min	Main connection	Noise emission in 1m/3m distance tolerance +2dB(A)  db(A)	Weight at 3 m track height	Weight each m more lifting height
500/1	AP 405 TI8	6,5	7,8	2m/M5	0,75	1,2	R ½ "	93/84	65	0,6
1000/2	AP 410 TI8	3,25	3,9	2m/M5	0,75	1,4	R ½ "	93/84	75	1
1000/1	AP 610 TI15	6,2	7,4	2m/M5	1,5	2,1	R ¾ "	94/84	103	1,3
1600/1	AP 716 TI25	6,7	8	2m/M5	2,5	3,5	R 1 "	94/84	128	2,1
2000/2	AP 620 TI15	3,1	3,7	2m/M5	1,5	2,1	R ¾ "	94/84	107	2,5
2000/1	AP 820 TI35	*)	*)	2m/M5	*)	*)	*)	*)	*)	*)
3200/2	AP 732 TI25	3,35	4	2m/M5	2,5	3,5	R 1 "	94/84	135	3,9
3200/2	AP 832 TI35	*)	*)	2m/M5	*)	*)	*)	*)	*)	*)
5000/2	AP 850 TI35	*)	*)	2m/M5	*)	*)	*)	94/84	*)	*)

Table 2

Capacity/ number of falls  kg	Type	Speed  lifting  m/min	Speed  lowering  m/min	FEM 9.511/ ISO 4301	Motor output  kW	Air con- sumption  m3/min	Main connection	Noise emission in 1m/3m distance tolerance +2dB(A)  db(A)	Weight at 3 m track height	Weight each m more lifting height
5000/1	AP 905 TI50	1,4	1,8	2m/M5	2,5	3,5	R 1 "	94/84	280	6
6300/1	AP 906 TI50	1,4	1,8	1Bm/M3	2,5	3,5	R 1 "	94/84	280	6
10000/2	AP 910 TI50	0,7	0,9	2m/M5	2,5	3,5	R 1 "	94/84	370	11,7
12000/2	AP 912 TI50	0,7	0,9	1Bm/M3	2,5	3,5	R 1 "	94/84	370	11,7
15000/3	AP 915 TI50	0,45	0,6	2m/M5	2,5	3,5	R 1 "	94/84	450	17,4
20000/4	AP 920 TI50	0,35	0,45	2m/M5	2,5	3,5	R 1 "	94/84	565	23,1
25000/5	AP 925 TI50	0,3	0,35	2m/M5	2,5	3,5	R 1 "	94/84	605	28,8
30000/6	AP 930 TI50	0,25	0,3	2m/M5	2,5	3,5	R 1 "	94/84	*)	*)

\*) This information was not available by the printing deadline.

Air pressure 6bar

HADEF chain hoists AK+AP 4-10 are fitted with high-quality load chains. These chains meet all technical requirements as per EN 818-7-T.

Type AK+AP	chain
4	5 x 15
6	7 x 21
7	9 x 27
8	11,3 x 31
9	16 x 45
10	23,5x66

**Trolleys**

Capacity  kg	Lifting unit  Typ	Trolley  Typ	Trolley  Typ	Hand chain pull approx.  daN	Trolley  Typ	Travel speed  m/min	Travel motor output  kW	max. Wheel pressure  daN **)	Setting range for beam flange width from - to	
									Lastbolzen 1N  mm	Lastbolzen 2N  mm
500/1	AP 405 TI8	AFR10	AFH10	4	AFP10	8	0,75	140	50-135	136-220
1000/2	AP 410 TI8	AFR10	AFH10	8	AFP10	8	0,75	266	50-135	136-220
1000/1	AP 610 TI15	AFR20	AFH20	6,5	AFP20	8	0,75	277	66-186	187-306
1600/1	AP 716 TI25	AFR32	AFH32	6	AFP32	8	0,75	439	74-196	197-310
2000/2	AP 620 TI15	AFR20	AFH20	12,5	AFP20	8	0,75	529	66-186	187-306
2000/1	AP 820 TI35	AFR32	AFH32	8	AFP32	8	0,75	539	74-196	197-310
3200/2	AP 732 TI25	AFR32	AFH32	12,5	AFP32	8	0,75	842	74-196	197-310
3200/2	AP 832 TI35	*)	*)	*)	*)	8	0,75	*)	*)	*)
5000/2	AP 850 TI35	*)	*)	*)	*)	8	0,75	*)	*)	*)
5000/1	AP 905 TI50	--	AFH50	7	AFP50	8	0,75	2110	119-215	216-312
6300/1	AP 906 TI50	--	AFH50	9	AFP50	8	0,75	2625	119-215	216-312
10000/2	AP 910 TI50	--	AFH100	14	AFP100	8	0,75	3530	119-215	216-312
12000/2	AP 912 TI50	--	AFH100	17	AFP100	8	0,75	4210	119-215	216-312
15000/3	AP 915 TI50	--	AFH100	20	AFP100	8	0,75	4980	131-221	222-310
20000/4	AP 920TI50	--	AFH100	27	AFP100	8	0,75	6785	160-310	--
25000/5	AP 925 TI50	--	AFH100	22	AFP100	8	0,75	7810	160-310	--
30000/6	AP 930 TI50	--	AFH100	*)	AFP100	8	0,75	*)	160-310	--

\*) This information was not available by the print deadline

\*\*) Wheel pressure including the weight of the hoisting device and trolley at nominal load and 3 m suspension height.

Air pressure 6bar

**Trolleys - Weights**

Type	Proper weight approx.. kg	Type	Proper weight approx.. kg	Type	Proper weight approx.. kg
AFR10	12	AFH10	14	AFP10	26
AFR20	23	AFH20	26	AFP20	41
AFR32	39	AFH32	42	AFP32	56
AFR50	61	AFH50	65	AFP50	68
AFR100	160	AFH100	165	AFP100	180

Weights for 3m suspension-, or track height

**6 Installation**

**6.1 Stationary hoist AKS + APS**

Stationary designs are supplied with a suspension eye. A suspension hook is available as option.

They are usually supplied assembled in full. In exceptional circumstances, the suspension eye/ suspension hook is not assembled.

If a change is made from a one to a two chain fall design the suspension eye or the suspension hook must be adjusted.

 **WARNING!**  
The hoist must always hang centrally under the beam or under its suspension point.

AK+AP 4-8, single and double chain falls

For single or double chain falls, the suspension eye (1) or the suspension hook must be connected to the two or three holes of the housing (2) so that the load is placed centrally under the suspension point.



Illustration 3

AK+AP 4-8, modification from single chain fall to double chain falls

In case of modification from single to double chain falls or vice versa, it is important that the suspension eye (1) or the suspension hook is moved to a position so that the load hangs centrally again.

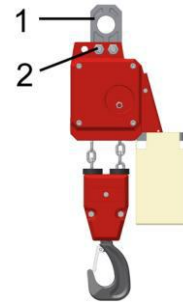

Illustration 4

AK+AP 9-10, single and several chain falls

The stationary type with suspension eye can optionally also be supplied with suspension hook. As standard they are supplied assembled in full.

The hoist with suspension eye (1) is fitted with two holes. Assemble the suspension eye (1) between the two brackets (2).

Insert the bolt.

In order to avoid confusion of the holes, they have different sizes.

The larger hole must take the entire load and part of the proper weight of the hoist. The smaller hole must take the remaining weight. The bolts must be chosen according to their loading.

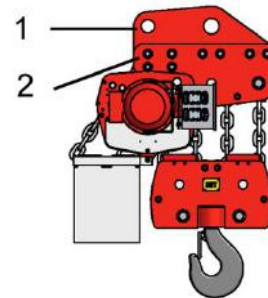



Illustration 5

 <b>CAUTION!</b>
If this is not observed it may damage the chain feed-in.

The assembly and installation depends on the local environment. The hoist must be suspended in a way that it can position itself freely.

## 6.2 Trolley

For assembly on a beam a travel limit must be placed at either end of the track.

This must be attached so that any elastic limitation buffer or the trolley wheels are driven against them in their end position when moving.

Generally, additional lifting gear (e.g. fork lift, lifting platforms) will be required for the assembly. These must take the weight of the devices securely.

### 6.3 Assembly on the beam AK+AP 402 to AK+AP 912

#### 6.3.1 Outline:

- Side plate (1)
- load bolt (2)
- hexagon nuts (3)
- safety nuts (4)
- distance tubes (5)
- washers (6)
- traverse (7)
- beam width (B)
- gauge (X)

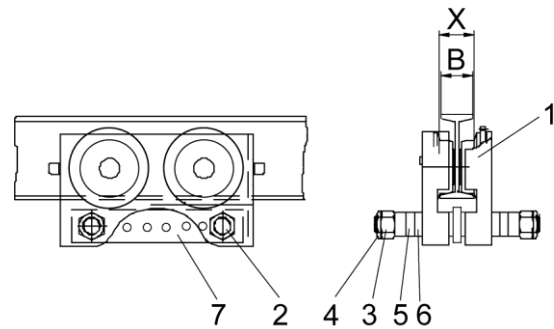



Illustration 6

#### 6.3.2 Procedure

- 1 Pre-assemble the side plates (1) to fit the gauge "X".
- 2 Push on the unit at the face of the beam flange.

If this is not possible for lack of space or fixed end stops the trolley can also be installed on the beam from below.

- 1 Unscrew the hexagon nut (3) and safety nuts (4) at one side and pull apart the side plates (1) as far until it is possible to push the trolley onto the beam flange from below.
- 2 Push the trolley together again until it reaches the correct wheel gauge (X).
- 3 Secure the washers (6) and distance tubes (5) by tightening the hexagon nuts (3) and the safety nuts (4).
- 4 Make sure the washers (6) and distance tubes (5) are placed symmetrically.

 **WARNING!**  
The hoist must always hang centrally under the beam or under its suspension point.

 **CAUTION!**  
The distance "X" between the wheel flanges of the trolley wheels must exceed the flange width "B" of the beam by 2-3 mm (1-1,5 mm each side).

Traverse for trolley installation for chain hoists with 1-and 2-falls  
AK7+AK8

Dimensions mm	AK+AP 402+405	AK+AP 410	AK+AP 610	AK+AP 620	AK+AP 716	AK+AP 732	AK+AP 820	AK+AP 832+840	AK+AP 850
D	21	21	31	31	37	37	37	37	40
H1	332	397	418	520	494	634	496	586	592
H2	50	50	65	65	75	75	100	100	100
M	M 12	M 12	M 16	M 16	M 20	M 20	M 24	M 24	M 24
L	215	215	245	245	290	290	380	380	454
L1	82,7	107,5	87,25	122,25	101,25	144,75	190	190	227
L2	24,6	24,6	34,5	34,5	43,5	43,5	50,3	50,3	50,3
S	15	15	15	15	20	20	20	20	20

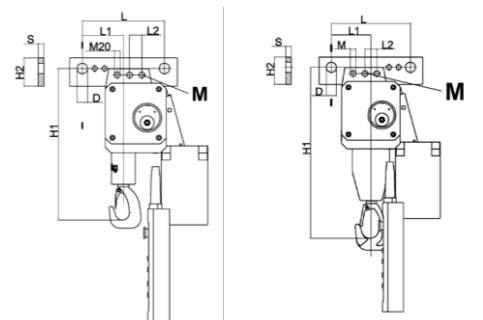

Illustration 7

**6.4 Assembly on the beam AK+AP 915 - 930, AK+AP1010 - 1025**

**6.4.1 Outline:**

- side plates (1)
- load bars (2)
- washers (3)
- traverse (4)
- safety rings (5)
- hexagon screws (6)
- safety nuts (7)
- serrated lock washer (8)
- beam flange width (B)
- gauge (X)

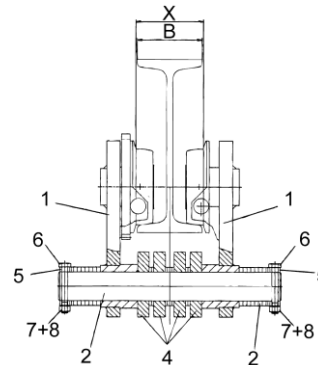



Illustration 8

**6.4.2 Procedure**

- 1 Pre-assemble the side plates (1) to fit the gauge "X".
- 2 Push on the unit at the face of the beam flange.

If this is not possible for lack of space or fixed end stops the trolley can also be installed on the beam from below.

- 1 Remove the safety rings (5) and safety screws (6) at one side.
- 2 Pull apart the side plates (1) as far until it is possible to push the trolley onto the beam flange from below.
- 3 Push the trolley together again until it reaches the correct wheel gauge (X).
- 4 Place the washers (3) again.
- 5 Make sure the washers (3) are placed symmetrically.
- 6 Secure the hexagon screws (6) with serrated lock washers (8) and safety nuts (7).
- 7 Place the safety ring (5) again.

 **WARNING!**  
The hoist must always hang centrally under the beam or under its suspension point.

 **CAUTION!**  
The distance "X" between the wheel flanges of the trolley wheels must exceed the flange width "B" of the beam by 3-5 mm (1,5-2,5 mm each side) .

dimensions mm	AK+AP	AK+AP	AK+AP	AK+AP	AK+AP	AK+AP	AK+AP	AK+AP
	905	906	910	912	915	920	925	930
A	635	635	635	635	720	850	980	1440
A1	412	412	486	486	553	630	705	940
A2	72	72	146	146	217	290	370	435
B1	105	105	80	80	80	80	80	80
B2	139	139	104	104	107	107	107	145
C	70	70	148	148	157	168	179	205
C1	50	50	53	53	60	80	90	80
C2	55	55	65	65	65	90	100	110
D	52	52	61	61	61	71	76	80
D1	33	33	41	41	41	61	61	61

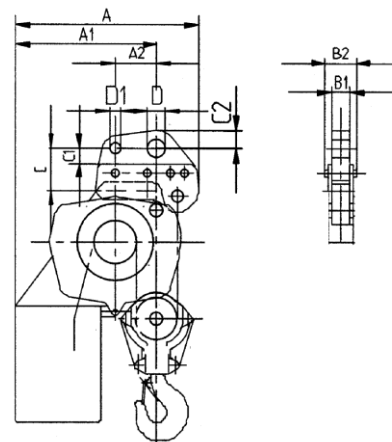

Illustration 9

dimensions mm	AK+AP1010 AK+AP1012	AK+AP1020 AK+AP1025
A	660	774
A2	107	214
B1	80	80
B2	222	222
C1	4205	80
C2	65	110
D	50	76,5
D1	50	61,5

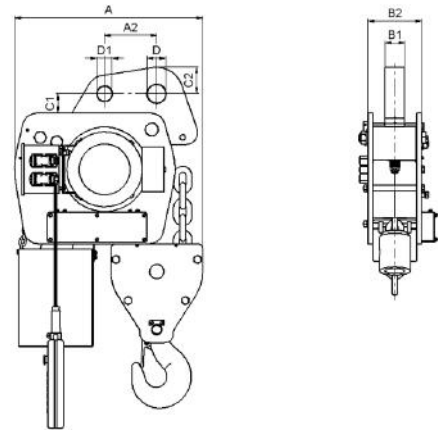
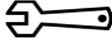
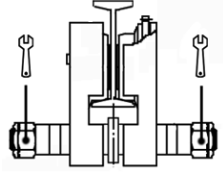
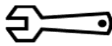
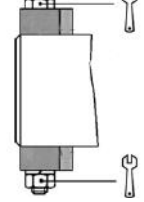
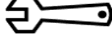
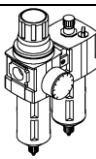

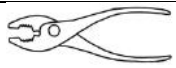
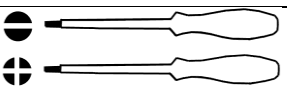

Illustration 10

### 6.5 Tools

Capacity	Size	Tool	Use	
0,5t 1t 1,5t + 2t 2,5t + 3,2t 5t + 6,3t 7,5t + 10t	SW27 SW36 SW46 SW55 SW60 SW75		Load bar	
12,5t 16t – 60t	SW22 SW24		Load bar with fixing ring	
	diff.		Air connection	
			diff.	
			diff.	
	diff.		diff.	

## 7 Operation

Only people that are familiar with the operation of the lifting devices and cranes may be entrusted with their operation. They must be authorized by the employer for the operation of the equipment. The employer must ensure that the operating instructions are available near the equipment and that they are accessible for the operating personnel.

The shown control switches are only for the optical information. They can be different acc. the delivery.



**Direct control**

- 1 Emergency-Stop
- 2 Lifting
- 3 Lowering

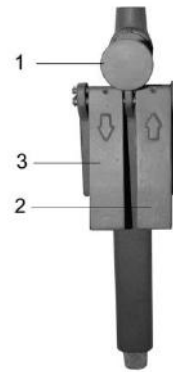

Illustration 11

**Indirect pneumatic control**

- 1 Emergency stop
- 2 lifting
- 3 lowering

Hoists combined with trolleys have control switches where push buttons for trolley movement are added.  
Special design units can be supplied upon request.



Illustration 12

**Push button functions**

Relieved push button = stand still  
push button pushed = respective movement



Illustration 13

Red Emergency-Stop button

button pushed = stand still  
turn the button clockwise = free functions



Illustration 14

**Emergency release – Hoist (as option)**

To drain the load at pressure drop in an emergency case, a manual brake release is possible by lever (A).

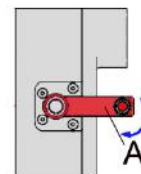

Illustration 15

**8 Operation**

The following, important points must be observed when operating the equipment:

- Read the safety instructions.
- Never load the devices beyond their working load limit.
- The prescribed maintenance intervals must be adhered to.
- The lifting tackle or the load must be securely attached to the hook and be seated at the bottom of the hook. The safety catch must always be closed.

 **DANGER!**

It is not allowed:

- pulling loose of stuck loads, dragging of loads and inclined pulling is not allowed.
- in explosive atmosphere, except the unit is especially modified for it and marked by an indication label
- to transport people
- The device is not suitable for use on stages and in studios
- persons must not stand under a suspended load

## 9 Commissioning

### 9.1 General

Should the unit be used in Germany:

Please observe the validated, national accident prevention regulations.

For other countries:

Inspections as above. Please observe the national rules and regulations and the instructions in this manual!

 **NOTICE!**

Hoists up to 1000 kg capacity and without motor-driven trolleys of hoisting unit must be tested by a “qualified person” before putting into operation for the first time.

Hoists of 1000 kg capacity and up or with more than one motor-driven hoist movement; i.e. lifting and trolley movement, must be tested by a “licensed qualified person” before putting in operation.

An exception is “hoists ready for operation” acc. validated national regulations with EU-declaration of conformity.

**Definition “qualified person” (former expert)**

A “qualified person” has learned, due to occupational training and experience and the job that the person has done, the skills needed to tests the material for one’s work.

**Definition “licensed qualified person” (former approved expert)**

A “licensed qualified person” has, due through special occupational training, knowledge about testing of the material for one’s work and knows the national accident prevention regulations and other prescriptions and technical regulations. This person must test the material for one’s work regularly with regard to design and kind of use. The license will be given to qualified person be the approved supervision authorities (ZÜS).

### 9.2 Compressed air connection

Before commencing work on the equipment, the main air supply line must be closed and secured against inadvertent opening!

#### 9.2.1 Main connection

- The connections must be made according to the pneumatic connection diagram.
- Connect to the existent hose nozzle.
- The hose must be secured with a hose clamp.

Nominal width of the air connection hose

0,52-0,75 kW - NW 13 mm

1,5 kW - NW 19 mm

2,5 kW - NW 25 mm

If hose length exceeds 15 m, a larger cross section must be selected.

#### 9.2.2 Control hose connection

Control switches with hoses are connected at the factory, unless otherwise agreed.

### 9.2.3 Maintenance unit

It is important that an automatic maintenance unit, consisting of oiler, filter, water separator and air pressure reducer is installed in the main air supply - if not assembled by the manufacturer this must be assembled by the customer.

It serves for the necessary preparation of the operation air so that the pneumatic motor can work trouble-free. Installation must be as close as possible to the motor; - in no cases should the distance to the motor exceed 10 m.

Should higher pressure occur in the supply net, it will be reduced to the operating pressure of 6 bar by the pressure reducing valve. The oiler enriches the air with oil. Setting of oil addition: approx. 2 drops of oil must be added per minute.

#### **NOTICE!**

HADEF does not assume any responsibility for damage caused by non-observance of the instructions.

#### **CAUTION!**

Should the unit be assembled at the customer, the maintenance unit is supplied without oil.

Before putting the unit into operation, the main air supply line must be cleaned and the oiler of the maintenance unit must be filled with oil. Should this not be done the unit may be severely damaged.

#### **CAUTION!**

The maintenance units are not approved for use with synthetic oil.

They must not be connected to compressed air systems which are supplied by compressors with synthetic lubricants.

### 9.3 Gear

#### **NOTICE!**

For transport, some gear types are fitted with a plug screw. Replace the plug screw by a ventilation screw (attached) before putting the unit into operation.

### 9.4 Load chain

- Before commissioning the load chain must be aligned and oiled.
- Move safety note and fixing wire away from the chain.

#### **CAUTION!**

Do not use grease for lubrication of load chain.

Without lubrication, manufacturer's warranty and/or liability will be void.

#### **NOTICE!**

Continuous, thorough lubrication will increase the life of the chain considerably.

## 10 Safety check

Before putting into service initially or when putting back into service, it must be checked whether:

- All fastening screws (if existent), socket pins, flap socket and safety devices are tightened and secured.
- The oil levels in the gear boxes are sufficient.
- All movements of the load comply with the symbols on the control switch.
- The chains are correctly placed, oiled and in good condition.

## 11 Functional test

### 11.1 Checks before the initial start-up

#### Lifting gear

- Load chains must not be twisted.
- Lubricate the load chain with gear oil or suitable chain lubricant before first loading.

#### Trolley drive

- The open-lying teeth of the trolley drive must be lubricated.

#### Hand gear for hand geared trolley

- Ensure correct fit of the hand chain, it must not be twisted and must hang freely.

### 11.2 Functional test

#### Lifting gear

Check lifting and lowering functions, initially without a load. The buttons of the control switch are marked with the symbols for lifting and lowering. The movement direction of the load (lifting or lowering) must correspond with the push buttons (lifting or lowering). This is the factory setting.

If the device lowers when the “lift” button is operated and lifts when the “lower” button is operated, the two phases of the net connection must be swapped.

The function of the end switch is to be checked initially by operating the end switch by hand. Then carefully move to the end position. If required, adjust end switch.

Then check the brake function under load. After releasing the buttons of the control switch, the load must be securely held.

#### Trolleys

Carefully move the trolley to the end positions and check the positions of the end stops.



#### **NOTICE!**

The limit switch function will only work if the movement direction of the load (lifting - lowering) corresponds to the push buttons of the control switch.

## 12 Maintenance

### 12.1 General

All monitoring, servicing and maintenance operations are to ensure correct functioning of the equipment; they must be effected with utmost care.

- Only “qualified persons” may do this work.
- Servicing and maintenance work must only be done when the hoist is not loaded.
- Records must be kept of all test results and measures taken.

### 12.2 Monitoring

The monitoring and servicing intervals stated are valid for operation under normal conditions and single-shift operation. In case of severe operating conditions (e.g. frequent operation with full load) or special environmental conditions (e.g., heat, dust, etc.), the intervals must be shortened correspondingly

### 12.3 Replacing the load chain



#### **CAUTION!**

If there is any visible damage and when the conditions for replacement are reached (i.e. one or several dimensions in the table have been reached, there is corrosion or elongation), the chain must be replaced.

When replacing the chain, also check the chain wheels.

Procedure:

- Only insert new chains in an unloaded state and as the chains that are currently in the device – i.e. not twisted.
- Remove chain from its fastening at the end and attach a chain link which is open at the side.
- A chain link which is open at the side, can easily be produced by grinding out a small piece. The opening must have the same thickness as the chain link.
- Hang a new original chain (same size and oiled) in the side opened chain link and insert it.
- Make sure the chain is not installed twisted.
- Make sure the chain links are aligned in one direction.
- Assemble the chain to the end fastening.

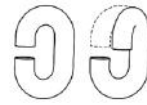

Illustration 16

Running of the chain into the chain container:

- Always run chains into the chain container by using the motor.

 **CAUTION!**  
 Fill in the chain always motor driven.  
 Never run the chain in by hand, as there is a risk of knotting which can cause malfunctions and damage to the device.

**for hoists Type 4-8 with spur gear**

 **NOTICE!**

The weld seam of the chain must lie to the inner side and be in contact with the sprocket wheels.

**for hoists Type AK 9-10 with planetary gear**

 **NOTICE!**

The weld seam of the chain must lie to the outer side and must not be in contact with the sprocket wheels.

**Only for AK+AP 4-8**

Chain end fastening 2 chain falls  
 Type with threaded bolt (1)

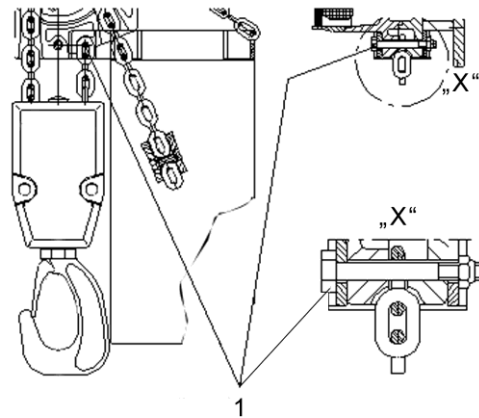

Illustration 17

chain threaded bolt AK+AP 4-8

	AK+AP4	AK+AP6	AK+AP7	AK+AP8
dn mm	6	8	10	12
dv mm	5,4	7,2	9	11

Exchange the bolt if the wear limit "dv" is reached.

Max. permitted wear < 10%.

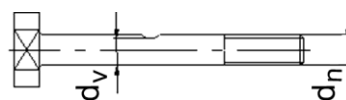

Illustration 18

## 12.4 Pneumatic motor

- The thickness of the brake lining must be checked at least once a year.
- Check the function of the brake daily.
- Assembly and disassembly of the brake lining (1) must only be effected by a "trained expert".
- When the wear limit thickness of the brake linings is reached, the linings including their carrier must be exchanged.
- Adjustment is not possible.
- Only use original spare parts.

Motor output kW	brake lining thickness B min. mm
0,52-0,75	6,0
1,5-2,5	6,5

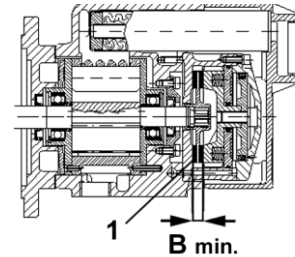



Illustration 19

## 12.5 Overload protection

If the hoist does not lift the permitted load, the overload protection must be adjusted. Adjustment may only be done by a service company, authorised by the manufacturer!



**DANGER!**

The factory setting of the overload protection is secured by a seal. Any guarantee becomes invalid if this setting is changed. Should maintenance be necessary, please contact a service company that is authorised by the manufacturer.

Depending on the type of hoist, the following variants are possible:

### 12.5.1 Slipping clutch



Illustration 20

### 12.5.2 Mechanical spring assembly

In case of overload the load must be lowered until it reaches the ground so that the spring assembly can release. Only thereafter it is possible to repeat the lifting motion.

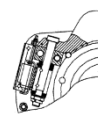

Illustration 21

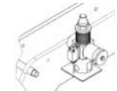

Illustration 22

### 12.5.3 Overload protection by pressure limiting valve

Factory setting for the desired load at 6 bar.

Normally this setting does not need to be adjusted.



Illustration 23

## 13 Inspection

### 13.1 General Overhaul for motor-driven units

The validated, national accident prevention regulations must be observed and the measures to reach "safe working periods (S.W.P.)" according to FEM 9.755.

After the "theoretical working time D" has been elapsed, the owner/user must take motor driven devices out of operation and effect a General Overhaul.

Further use of the equipment is only allowed after a licensed qualified person has proofed

- that further use is possible without doubt

and

- the conditions for further use have been determined

**These conditions have to be written down in the test book.**

The owner/user is responsible to make sure that these conditions are observed.

### 13.2 Periodic checks

Independently from the regulations of the individual countries, lifting devices must be checked at least yearly by a qualified person or licensed qualified person regarding its functional safety.

#### 13.2.1 Components to be checked

The following must be checked:

- Dimensions of load chain, load hooks, pawls, bolts, ratchet wheels, brake linings.  
The dimensions must be compared to the dimensions in the tables.
- A visual inspection for deformations, cracks and corrosion must be carried out.

#### 13.2.2 Inspection intervals

	at commissioning	daily checks	1st maintenance after 3 months	Inspection and maintenance every 3 months	Inspection and maintenance every 12 months	Inspection and maintenance every 36/60 months
Inspection of the equipment by a qualified person (periodic inspection)					X	
screw connections	X				X	
brake function - brake discs	X	X				
overload protection as slipping clutch (if relevant)	X				X	
overload protection by current cut-off (electric hoist) (if relevant)	X				X	
overload protection by air relieve valve (pneumatic hoist) (if relevant)	X				X	
load chain, clean and oil	X	X*)	X	X		
load chain, elongation and wear				X		
load hook, cracks and deformation					X	
Bearings of chain pulleys, check and lubricate					X	
Hoist gear, oil change						X*)
Trolley wheels, wear					X	
Trolley wheels, lubricate toothed wheels	X*)		X*)	X*)		
*) see chapter "maintenance"						

### 13.3 Checking the load chain

acc. DIN 685-part 5

L11 = pitch increase over 11 chain links

L1 = pitch increase over 1 chain link

dm = detected link thickness

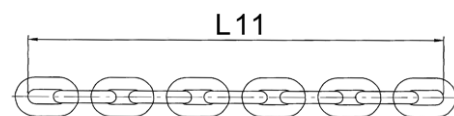

Illustration 24



**Chain dimensions**

Dimensions mm	Chain size					
	5x15	7x21	9x27	11,3x31	16x45	23,5x66
L11	171,4	238,8	300,8	348,1	505,6	743,0
L1	16,0	22,4	28,1	32,7	47,4	69,5
dm	4,6	6,5	8,2	10,2	14,4	21,2

**WARNING!**  
When the dimensions listed in the table are reached due to wear or deformation, the chain must be replaced!

**13.4 Checking the load hook**

load hook and suspension AK 4 - AK 8

a1/a2 = biggest hook mouth width

h1 = eye dimension

t1/t2 = thickness of hook base

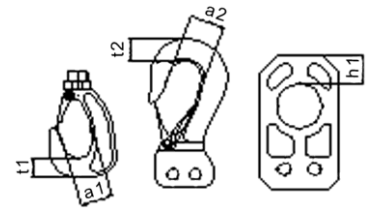

Illustration 25

load hook AK 9 + AK10

X = biggest hook mouth width

Y = measurement from hook no. 6 up

H = thickness of hook base

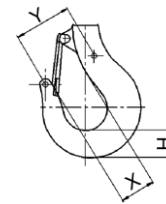

Illustration 26

**Dimensions for load and suspension hook and eye for AK+AP 4-8**

Dimension mm	AK+AP4		AK+AP6		AK+AP7		AK+AP8	
	Susp. a load		Susp. a load		Susp. a load		Suspension	
	1-str.	2-str.	1-str.	2-str.	1-str.	2-str.	1-str.	2-str.
a1 max.	37,5	43,5	43,5	60,0	60,0	69,5	--	--
a2 max.	39,0	39,0	57,0	57,0	57,0	66,0	60	60
h1 min.	18,0	18,0	31,0	31,0	31,0	40,0	40,5	40,5
t1 min.	17,1	20,9	20,9	27,6	27,6	40,0	--	--
t2 min.	21,9	21,9	33,4	33,4	33,4	63	77	77
								Load hook
Hook No.	--	--	--	--	--	--	1	1,6
X	--	--	--	--	--	--	40	45
H	--	--	--	--	--	--	40	48

Please fill in the measured values before commissioning:

Capacity	t
a1	mm
a2	mm
h1	mm
t1	mm
t2	mm
X	mm
H	mm

**Dimensions for load and suspension hook and eye for AK+AP 9-10**

Dimension mm	Capacity in t / falls									
	5/1	6,3/1	10/2 10/1	12/2 12/1	15/3	20/4 20/2	25/5	25/2	30/6	40/8
Hook no.	1,6	1,6	4	4	6	6	8	6	10	12
X	45	45	56	56	--	--	--	--	--	--
Y	--	--	--	--	130	130	145	130	160	180
H	48	48	67	67	85	85	95	85	106	118

Please fill in the measured values before commissioning:

Capacity	t
X or Y	mm
H	mm

**CAUTION!**  
When the dimension of hook opening width is deformed more than 10% or when the dimension of the hook bottom thickness is fallen short of by 5% due to wear, the hook must be replaced.

### 13.5 Inspection – Gear – Oil level

Check oil level all 3 month.

	Locking screw(C)	Tool
AK 4 – AK 6	M10	SW8
AK 7 – AK 8	M12	SW10

Solve the locking screw (C) a bit. (do not remove)  
 If oil drips out = level OK.  
 Tighten the screw.

If no oil drips out, carry out maintenance and oil change.  
 (see chapter maintenance)

AK 9 - 10	Oil gauge glass (C)
-----------	---------------------

Oil gauge glass half full = level OK  
 No oil observable = carry out maintenance and oil change.  
 (see chapter maintenance)

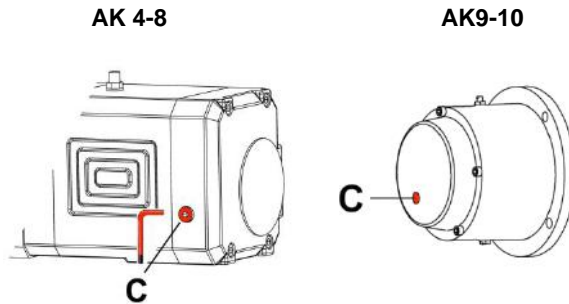



## 14 Service

### 14.1 Load chain

Wear at the links is mainly due to insufficient maintenance of the chain.

To ensure optimal lubrication of the links, the chain must be lubricated at regular intervals, depending on usage.

- Lubricate the chain with a lubricant that creeps, e.g. automotive gear oil.
- Always lubricate the chain when it is not under load so that the oil can wet the links affected by wear. It is not sufficient to lubricate the chain from the outside, as this will not ensure the formation of a lubricating film within the links. The adjacent link points must always be lubricated to prevent excessive wear.
- If the same lifting operations are carried out constantly, the switching area from a lifting to a lowering movement must be given special attention.
- Thoroughly effected lubrication of the chain will prolong the life of the chain by approx. 20 times, compared to dry run with unlubricated chain.
- Wash dirty chain with petroleum or a similar cleaner, under no circumstances heat the chain.
- If there are environmental influences that foster wear, such as sand, a dry lubricant should be used, e.g. graphite powder.
- When lubricating the chain's condition of wear should be checked.



Use		Recommendation		Interval
Load chain		Gear oil for example: FUCHS RENOLIN PG 220 or special chain lubricant Use <b>NO</b> grease!	0,2 l	3 month

### CAUTION!

Do not use grease for lubrication of load chain.

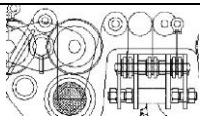

Without lubrication, manufacturer's warranty and/or liability will be void.

### 14.2 Pulleys

Use		Recommendation		Interval
Pulleys		FUCHS RENOLIT FEP2	Acc. to demand	12 month

### 14.3 Load hook

- Check bearings and pulleys yearly
- Clean and lubricate the bearings of hooks and pulleys with grease
- Slight bearings are maintenance free
- When bearings resp. slight bearings are worn of, change the complete pulley

Use		Recommendation		Interval
Load hook bearing		FUCHS RENOLIT FEP2	Acc. to demand	12 month

### 14.4 Hoist gear

- Low maintenance.
- Regular lubricant checks required
- Exchange synthetic lubricants after 3 years
- Shorter maintenance intervals for particularly difficult operating conditions, e.g. increased dust and pollution loads or constant operation of the hoist with the highest load
- Lubricant: synthetic, viscosity VG 220

A = Oil fill in or air discharge screw

B = Oil drain plug

C = Oil level glass

AK4 – AK8

AK9+AK10

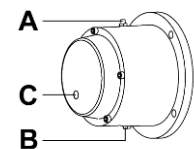
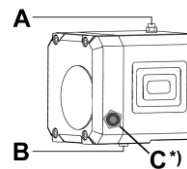

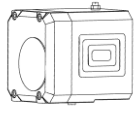
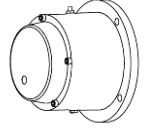





Illustration 27

Use		Recommendation		Interval
Spur gear		FUCHS RENOLIN PG 220	AK/AP4 – 0,80 l AK/AP6 – 1,00 l AK/AP7 – 1,90 l AK/AP8 – 1,90 l	Lubricant change 3 years
Planetary gear		FUCHS RENOLIN PG 220	AK/AP9 = 0,4 l AK/AP10 = 3 l	Lubricant change 3 years
Spur gear *) Planetary gear			Maximum fill level = gauge full filled Minimum fill level = gauge half filled	

\*) only by explosion proof electrical equipment

### 14.5 Trolley

- Trolleys are lifetime lubricated, Refill lubricant is normally not necessary.
- Lubricate gear rim and pinion drive each ¼ year or if required more often, with grease.

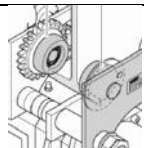
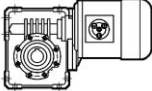
Use		Recommendation		Interval
Pulleys Gear rim Drive pinion		FUCHS RENOLIT FEP2	0,1 kg	3 month
Travelling gear If available		SHELL Tivela S320	---	Life time lubrication

### 14.6 Pneumatic motor

The pneumatic motor must be lubricated continuously by a maintenance unit.

If not otherwise agreed, the maintenance unit must be installed by the customer.



Should a maintenance unit be part of the consignment, the oiler must be filled with oil before the first start.



After longer periods of standstill, gummy oil or slight rust may lead to the fact that the motors do not start at once or do not perform well. In most cases, this problem can be resolved by adding a few cubic meters of cleaning oil or paraffin into the supply hose and carrying out a test run. Afterwards, fill the same quantity of oil into the hose and repeat the procedure to ensure that the oil is well distributed. The lubrication is then carried out by the oiler of the maintenance unit.

Recommendation:

Should longer periods of standstill be foreseen, insert some cubic meters of oil into the air supply hose after the last use of the unit and let the motor run shortly. This will prevent corrosion.

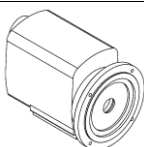
Lubricant: FUCHS Renolin B10 or a similar product.

Use		Recommendation		Interval
Pneumatic motor		FUCHS RENOLIN B10	0,1l	3 Monate

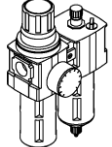
Use		Recommendation		Interval
Maintenance unit		FUCHS RENOLIN B10	0,1l	1 month

## 14.7 Lubricant selection

FUCHS	SHELL	ESSO	ARAL	MOBIL	TOTAL	CASTROL	KLÜBER
Renolin PG 220	Tivela S 20	Glycolube 220	Degol GS 220	Glygoyle 30	CARTER SY 220	--	Klübersynt GH 6-220
Renolin PG 320	Tivela S 320	Glygolube 320	Degol GS 320	Glygoyle 320	--	--	Klübersynt GH 6-320
Renolin PG 460	Tivela S 460	Glygolube 460	Degol GS 460	Glygoyle 460	--	Alphasyn PG 460	Klübersynt GH 6-460
Renolit FEP2	Alvania EP2	Unirex EP2	--	Mobilux EP2	MULTIS EP2	--	--
Renolin B10 VG32	Tellus Oil 32	--	--	--	--	--	--
Stäblyan 5006	--	--	--	--	--	Optimol Viscoleb 1500	Klüberoil 4UH 1-1500

## 14.8 Lubricant for food industry – selection (as option\*)

	FUCHS	SHELL	MOBIL	CASTROL	KLÜBER
Gear	Geralyn SF 220	Cassida Fluid GL 220	Glygoyle 220	Optimol GT 220	Klübersynt UH1-220
Driving gear	Geralyn SF 320	Cassida Fluid GL 220	Glygoyle 320	Optimol GT 320	Klübersynt UH1-320
Load chain	--	--	Lubricant FM 100	Optimol Viscoleb 1500	--
Load hook Pulley Spur gear Pinion	--	FM Grease HD 2	Mobilegrease FM 222	--	--

\* must be mentioned by order

## 15 Trouble

Please pay attention to the following in case of problems:

- Troubles with the equipment must only be repaired by qualified personnel.
- Secure the unit against unintended operation start.
- Put up a warning note indicating that the unit is not to be used.
- Secure the working area of moving parts of the unit.
- Please read the chapter "Safety instructions".

Notes on the repair of faults are found in the following table.

For the repair of failures please contact our service department.



### **CAUTION!**

Trouble caused by wear or damage to parts such as wire ropes, chains, chain wheels, axes, bearings, brake parts, etc., must be remedied by replacing the parts with original spare parts.

## 16 Remedy

Problem*	Unit	Cause	Remedy
Unit cannot be switched on	Electric Hoists	No main power	Check connection to mains supply
		Phase sequence not correct (with low voltage control)	exchange 2 phases (see warning note at the plug)
Hoist motor does not run	Electric Hoists	Fuse burnt out	Replace the fuse
		Defective switching unit in the control button switch	Replace the switching unit
		Interruption in the control cable	Check control cable and replace if necessary.
		Defect of capacitor (only for alternating current 1).	Replace the capacitor
	Pneumatic hoists and winches	Defective coil - mechanic or electric overload	Motor must be repaired by a specialist If the unit is suitable for explosive atmosphere, the motor must be returned to the manufacturer for repair!
		Operation pressure/ quantity of air is too low	Check connection to mains supply
Hoist motor runs – load is not lifted	For motor driven chain hoists, and winches	After prolonged standstill	See maintenance - pneumatic motor
		Overload protection is activated - (with overload)	Reduce the load to nominal load
		Overload protection is activated - (with =< nominal load)	Check settings and reset if necessary
Hoist motor is running – chain does not lower	For motor driven chain hoists.	No or incorrect power transmission	Let the unit be repaired by an expert For EX-hoists, please clarify with the manufacturer what to do!*
		Blockage due to chain link pointing sideways in the feed from the chain container*	Check the chain - lubricate if necessary and/or select a larger chain container so that the chain can be properly arranged before the inlet
Motor hums and uses excessive current	Electric hoists and winches	Defective coil	Motor must be repaired by a specialist If the unit is suitable for explosive atmosphere, the motor must be returned to the manufacturer for repair!*
		Rotor is rubbing	Motor must be repaired by a specialist If the unit is suitable for explosive atmosphere, the motor must be returned to the manufacturer for repair!*
		Brake does not release	See problem "Brake does not release"
		Defect of capacitor (only for alternating current 1).	Replace the capacitor
		Defect of starter relay (only for alternating current 1).	Replace the starter relay
		Phase failure (only direct control)	Find the cause and repair
Motor does not brake or has excessive afterrunning.	Electric hoists and winches	Switching error after intervention in the electric circuit	Check the electric connection of the brake acc. to the wiring diagram
	For motor driven units.	Brake linings are worn or dirty.	Brake lining carrier must be changed completely If the unit is suitable for explosive atmosphere, the brake must be returned to the manufacturer for repair!*
		Air gap is too large	Re-adjust the air gap If the unit is suitable for explosive atmosphere, the brake must be returned to the manufacturer for repair!*
Brake does not release	Electric hoists and winches	Brake rectifier defective	Replace the brake rectifier If the unit is suitable for explosive atmosphere, the brake must be returned to the manufacturer for repair!*
		Brake current relay defective	Replace the brake current relay
		Brake coil is defective	Replace the brake coil If the unit is suitable for explosive atmosphere, the brake must be returned to the manufacturer for repair!*
		Permissible air gap is exceeded due to worn out brake lining	Re-adjust the air gap and exchange the brake lining if necessary If the unit is suitable for explosive atmosphere, the brake must be returned to the manufacturer for repair!*
	Pneumatic hoists and winches	Power drop in the mains power line > 10%	Provide correct power supply voltage
		Operation pressure/ quantity of air is too low	Check connection to mains supply
Fuses burnt out or motor contactor is triggered	Electric hoists and winches	Short circuit in component	Eliminate the short circuit
		Motor has a short circuit in the body or windings	Correct the problem by a specialist For EX-hoists, please clarify with the manufacturer what to do!*
		Motor is switched incorrectly	Correct the switching
		Wrong type of fuse	Replace the fuse with correct one (see table "fuses")

\*) as far as applicable

## 17 Decommissioning



### **WARNING!**

It is essential that the following points are observed in order to prevent damage to the equipment or critical injury when the device is being decommissioned:

It is mandatory that all steps for decommissioning the machine are carried out in the indicated sequence:

- First secure the working area for decommissioning, leaving plenty of space.
- Read the chapter "Safety instructions".
- Disassembly is carried out in reverse order to the assembly.
- Please make sure that all operating material is disposed of in accordance with environmental regulations.

### 17.1 Temporary decommissioning

- Measures are as above.
- Also read the chapter "Transport and storage".

### 17.2 Final decommissioning/disposal

- Measures are as above.
- After disassembly, ensure that the disposal of the equipment and any materials it contains is carried out in accordance with environmental regulations.

## 18 Additional documents

### 18.1 Pneumatic connections diagram

The pneumatic connections diagram is attached to the consignment.